

Business Message Standard (BMS)

for

Common Library

BRG: AII

BMS Release: 2.0

Document Version: 0.1.7

Release Date: 31.12.2004

(DD.MM.CCYY)



Change Request Reference

Refer to Change Request (CR) Number(s):	Not Applicable
CR Submitter(s):	Not Applicable
Date of CR Submission to GSMP:	Not Applicable

Business Requirements Document (BRAD) Reference

BRAD Title: ALL
BRAD Date:
BRAD Version:

Document Summary

Document Title:	BMS For Common Library
Document Version	0.1.7
Owner:	Global Business Process Modelling Team
Status:	(Check one box) <input type="checkbox"/> DRAFT <input checked="" type="checkbox"/> Approved
BMS Template Version:	1.0
Targeted BMS Publication Version	2.0

Document Change History

Date of Change	Version	Changed By	Reason for Change	Summary of Change	Model Build #
01.12.2004	0.1.0	Noel Yavo	Initial Version in BMS/BSD template	Migration of BRD to standard BMS/BSD format	4781 //depot/EAN.UCC/CRs/R2.0_Harmonization/EAN_UCC.mdl
07.12.2004	0.1.1	John Ryu	Maps to the GBM Structure. Ready for 1st draft XMI Development. Excludes Plan	Separated Common Library in chapter 3 (Common Components) and Chapter 4 (Process Common Components)	
09.12.2004	0.1.2	John Ryu	Updates	Summary of Changes	4948

			Finished Plan Common Li- brary	listed in section 1.10 Plan Common library section added in 4.7	
13.12.2004	0.1.3.	John Ryu	Updated to common li- brary	Reference section 1.10 changes	MDL P4CL : 5055
13.12.2004	0.1.4	John Ryu	Added Code Lists	Added code list into sec- tion 1.5.4 Updates identified in 1.10	MDL P4CL : 5094
16.12.2004	0.1.5	John Ryu	Updated to the Code List	Updates identified in 1.10	
17.12.2004	0.1.6	John Ryu	Update	Identified in 1.10	
24.04.2007	0.1.7	Giovanni Biffi	Editorial Changes	Minor Editorial Changes to the Document	

Business Message Standard

Table of contents

Chapter	Page
1 Business Solution Design	10
1.1 Business Domain View	10
1.1.1 Problem Statement / Business Need	10
1.1.2 Objective	10
1.1.3 Audience	10
1.1.4 Artefacts	10
1.1.5 References	10
1.1.6 Acknowledgements	10
1.1.6.1 BRG Members	11
1.1.6.2 ITRG Members	11
1.1.6.3 Task/Project Group Participants (<i>where applicable</i>)	11
1.1.6.4 Design Team Members	11
1.2 Business Context	12
1.3 Additional Technical Requirements Analysis	12
1.3.1 Technical Requirements (optional)	12
1.4 Business Transaction View	13
1.4.1 Business Transaction Use Case Diagram	13
1.4.1.1 Use Case Description	13
1.4.2 Business Transaction Activity Diagram(s)	14
1.4.3 Business Transaction Sequence Diagram(s) (Optional)	14
1.5 Information Model (including GDD Report)	14
1.5.1 Data Description:	14
1.5.2 GDD Report :	14
1.5.3 Class Diagrams	14
1.5.4 Code Lists	15
1.5.4.1 Account Number Type List	15
1.5.4.2 Activity Type Code List	15
1.5.4.3 Additional Party Identification List	15
1.5.4.4 Additional Trade Item Identification List	15
1.5.4.5 Allowance Charge List	16

Business Message Standard

Table of contents

1.5.4.6 Allowance or Charge List.....	16
1.5.4.7 Bar Code Type List.....	16
1.5.4.8 Billed Rate As Quantity Qualifier Type List.....	17
1.5.4.9 Buying Party Identification List	17
1.5.4.10 Collaboration Priority Code List	17
1.5.4.11 Collect On Delivery Code List.....	17
1.5.4.12 Collect On Delivery Funds Code List.....	17
1.5.4.13 Commodity Code List	18
1.5.4.14 Communication Channel Code List	18
1.5.4.15 Company Identification Format List	18
1.5.4.16 Correction Indicator List.....	18
1.5.4.17 Data Source Code List	19
1.5.4.18 Date Format List	19
1.5.4.19 Days of the Week List.....	19
1.5.4.20 Debit Credit Indicator List	19
1.5.4.21 Deliver Date Type List	19
1.5.4.22 Deliver Party Role List	20
1.5.4.23 Deliver Payment Method Code List	20
1.5.4.24 Deliver Reference Code List.....	20
1.5.4.25 Document Status List	22
1.5.4.26 Effective Date List.....	22
1.5.4.27 Entity Identifier Code List.....	22
1.5.4.28 Entity Type List	23
1.5.4.29 Equipment Type Code List	24
1.5.4.30 Exception Status Type Code List.....	25
1.5.4.31 Forecast Purpose Code List	25
1.5.4.32 Forecast Type Code List	25
1.5.4.33 Freight Invoice Payment Method Code List.....	25
1.5.4.34 Location Identification Format List.....	26
1.5.4.35 Master Handling Unit of Measure Code List.....	26
1.5.4.36 Message Reason List	26
1.5.4.37 Metric Type Code List.....	33

Business Message Standard

Table of contents

1.5.4.38	Package Status Activity Type Code List	33
1.5.4.39	Payment Format List	33
1.5.4.40	Payment Method List	34
1.5.4.41	Payment Terms Event List	34
1.5.4.42	Payment Terms Type List	34
1.5.4.43	Price Date Type List	35
1.5.4.44	Quantity Identification List	35
1.5.4.45	Rate Qualifier Type List	35
1.5.4.46	Residential Code List	36
1.5.4.47	Response Status List	36
1.5.4.48	Routing Number Type List	36
1.5.4.49	Scan Activity Code List	36
1.5.4.50	Service Level Code List	37
1.5.4.51	Settlement List	38
1.5.4.52	Shipment Exception Code List	38
1.5.4.53	Shipment Special Handling Code List	38
1.5.4.54	Shipment Status Code List	39
1.5.4.55	Shipment Status Reason Code List	41
1.5.4.56	Source Code List	44
1.5.4.57	Supplying Party Identification List	44
1.5.4.58	Time Format List	44
1.5.4.59	Transportation Method Type Code List	44
1.5.4.60	Truckload Special Service Code List	45
1.5.4.61	Weight Type List	46
1.6	Business Document Example	46
1.7	Implementation Considerations	46
1.8	Testing	47
1.8.1	Pass / Fail Criteria	47
1.8.2	Test Data	47
1.9	Appendices	47
1.10	Summary of Changes	48
2	XML Technical Solution ITRG Packet	51

Business Message Standard

Table of contents

3	Common Library Common Components	52
3.1	Package Overview: Components	52
3.1.1	Class Diagram: Date and Time	52
3.1.2	Class Diagram: Document.....	53
3.1.3	Class Diagram: Range	53
3.2	Package Overview: Compound Data Type	54
3.2.1	Class Diagram: Amount.....	54
3.2.2	Class Diagram: Code	54
3.2.3	Class Diagram: Description	55
3.2.4	Class Diagram: Long Description	55
3.2.5	Class Diagram: Measurement	55
3.3	Package Overview: Data Type	56
3.3.1	Class Diagram: Data Type	56
3.4	Package Overview: Extended Data Type.....	57
3.4.1	Class Diagram: Extended Data Type	57
3.5	Package Overview: Identification	58
3.5.1	Class Diagram Identification: Entity Identification.....	58
3.5.2	Class Diagram: Identification: Party Identification	58
3.5.3	Class Diagram: Identification: Trade Item Identification	59
4	Package Overview : Process Common Components	60
4.1	Package Overview: Catalogue Item Common.....	61
4.1.1	Class Diagram: Catalogue Item Common	61
4.2	Package Overview: Deliver Common.....	62
4.2.1	Class Diagram: Bill of Lading Collect On Delivery Information.....	62
4.2.2	Class Diagram: Bill of Lading Hazardous Information	63
4.2.3	Class Diagram: Binary Signature	63
4.2.4	Class Diagram: Carrier Identification.....	63
4.2.5	Class Diagram: Collect on Delivery Information	64
4.2.6	Class Diagram: Commodity Classification Information.....	64
4.2.7	Class Diagram: Commodity Group.....	64
4.2.8	Class Diagram: Deliver Date Information	65
4.2.9	Class Diagram: Deliver Location Information	65

Business Message Standard

Table of contents

4.2.10	Class Diagram: Deliver Package Measurements	65
4.2.11	Class Diagram: Deliver Payment Method.....	66
4.2.12	Class Diagram: Deliver Reference	66
4.2.13	Class Diagram: Deliver Shipment Information.....	66
4.2.14	Class Diagram: Deliver Weight Information.....	67
4.2.15	Class Diagram: Freight Invoice Common.....	67
4.2.16	Class Diagram: Interline Carrier	68
4.2.17	Class Diagram: Shipment Seal Information.....	69
4.2.18	Class Diagram: Stop Location Information	69
4.2.19	Class Diagram: Trade Item Unit Or Logistics Units	70
4.2.20	Class Diagram: Transactional Item Data	71
4.3	Package Overview: Global Search Common	72
4.3.1	Class Diagram: Party Search Result	72
4.3.2	Class Diagram: Registry Catalogue Item Search Result.....	72
4.3.3	Class Diagram: Trade Item Search Result	73
4.4	Package Overview: Order Common.....	75
4.4.1	Class Diagram: Order Logistical Information.....	76
4.4.2	Class Diagram: Order Party Information	77
4.4.3	Class Diagram: Simple Order Line Item	77
4.5	Package Overview: Party Synchronisation Common	78
4.5.1	Class Diagram: Party Capability.....	78
4.6	Package Overview: Pay Common.....	79
4.6.1	Class Diagram: Adjustment Reason.....	79
4.6.2	Class Diagram: Financial Institution Information	79
4.6.3	Class Diagram: Pay Code	79
4.6.4	Class Diagram: Payment Method.....	80
4.7	Package Overview: Plan Common.....	81
4.7.1	Class Diagram: Bulk Common	81
4.7.2	Class Diagram: Collaborative Trade Item.....	81
4.7.3	Class Diagram: Forecast and Forecast Revision Common.....	82
4.7.4	Class Diagram: Plan Document	82
4.7.5	Class Diagram: Replenishment Common	83

Business Message Standard

Table of contents

4.7.6	Class Diagram: Time Series Data Item	83
4.8	Package Overview: Price Common	85
4.8.1	Class Diagram: Price Date	85
4.9	Package Overview: Process Common	86
4.9.1	Class Diagram: Contact.....	86
4.9.2	Class Diagram: Name and Address	86
4.9.3	Class Diagram: Trade Item Hazardous Information	87
4.10	Package Overview: Price Common.....	88
4.10.1	Class Diagram: Response.....	88
4.11	Package Overview: Terms	89
4.11.1	Class Diagram: Allowance Charge.....	89
4.11.2	Class Diagram: Payment Terms.....	90
4.12	Package Overview: Trade Item Common.....	92
4.12.1	Class Diagram: Trade Item Market Information.....	92

Business Solution Design

1 Business Solution Design

1.1 Business Domain View

1.1.1 Problem Statement / Business Need

1.1.2 Objective

The objective to develop this common library is to enable the following.

- Contain and maintain all reusable data elements available in the EAN.UCC BMS Standards.
- Standardize the design and development process to produce consistent and quality products.
- Aids and protects the integrity of the GBM
- Gives visibility to internal development staff and external users to our available reusable components.

1.1.3 Audience

The primary audience for this document are individuals assigned as GS1 Business Process Analysts, Business Requirements Groups Managers, GDD Managers, and XML System Developers who are responsible for the completion and delivery of the Business Message Standards.

The secondary audience for this document are users involved in the GSMP activities with BRG, ITRG, PTRG.

1.1.4 Artefacts

Artefact name	State	Artefact / State description
Not Applicable		

1.1.5 References

Reference Name	Description
EAN.UCC Global Business Model (Process and Data), October 1999	
Simple eb(electronic business), March 2000	
GS1 Modeling Best Practices Version 0.6.0 for Publication 2.0	
Eb Methodology	

1.1.6 Acknowledgements

Business Solution Design

1.1.6.1 BRG Members

Function	Name	Company
None		

1.1.6.2 ITRG Members

Function	Name	Company / organisation
ITRG Chair	None	
ITRG Member		
ITRG Member		
ITRG Member		

1.1.6.3 Task/Project Group Participants (*where applicable*)

Function	Name	Company / organisation
Participant	None	
Participant		
Participant		

1.1.6.4 Design Team Members

Function	Name	Organisation
Modeller	John Ryu, Noel Yavo	GS1
XML Technical Designer		
EANCOM Technical Designer		
Peer Reviewer		

Business Solution Design

1.2 Business Context

Context Category	Value(s)
Industry	All
Geopolitical	All
Product	All
Process	All
System Capabilities	All
Official Constraints	None

1.3 Additional Technical Requirements Analysis

Not Applicable

1.3.1 Technical Requirements (optional)

(User Interface, Security, Performance, Quality, etc.)

Number	Statement	Rationale
	Not Applicable	

Business Solution Design

1.4 Business Transaction View

Not Applicable

1.4.1 Business Transaction Use Case Diagram

Not Applicable

1.4.1.1 Use Case Description

Not Applicable

Use Case ID			
Use Case Name			
Use Case Description			
Actors (Goal)			
Performance Goals	<i>Goals related to technical requirements</i> None		
Preconditions			
Post conditions			
Scenario	Begins when		
	Continues with...		
	Step #		
	1		
	2		
	3		
4			
Ends when...			
Alternative Scenario	Step #	Actor	Activity Step
Related Requirements	None		

Business Solution Design

Related Rules	None
---------------	------

1.4.2 Business Transaction Activity Diagram(s)

Not Applicable

1.4.3 Business Transaction Sequence Diagram(s) (Optional)

Not Applicable

1.5 Information Model (including GDD Report)

1.5.1 Data Description:

No Data Description

1.5.2 GDD Report :

No GDD Report

1.5.3 Class Diagrams

Reference Chapter 3 for Common Components.
Reference Chapter 4 for Process Common Components.

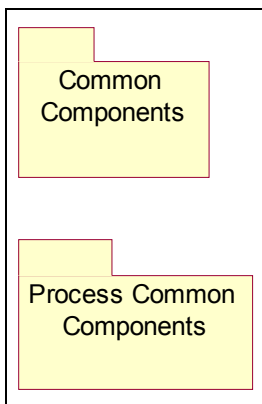

1.5.4 Code Lists

1.5.4.1 Account Number Type List

CodeName	CodeValue
01_TIME_DEPOSIT	N/A
03_CHECKING_ACCOUNT	N/A
10_BUSINESS_ACCOUNT	N/A

1.5.4.2 Activity Type Code List

CodeName	CodeValue
CANCELED_ORDERS	N/A
EMERGENCY_ORDERS	N/A
ON_HAND	N/A
ORDERS	N/A
RECEIPTS	N/A
SALES	N/A
SHIPMENTS	N/A

1.5.4.3 Additional Party Identification List

CodeName	Code-Value
BUYER_ASSIGNED_IDENTIFIER_FOR_A_PARTY	N/A
DEA_DRUG_ENFORCEMENT_AGENCY	N/A
DUNS	N/A
DUNS_PLUS_FOUR	N/A
HIN_CANADIAN_HEALTHCARE_IDENTIFICATION_NUMBER	N/A
SCAC	N/A
SELLER_ASSIGNED_IDENTIFIER_FOR_A_PARTY	N/A
TD_LINK_TRADE_DIMENSIONS	N/A
UCC_COMMUNICATION_IDENTIFICATION	N/A
UN_LOCATION_CODE	N/A
USDA_ESTABLISHMENT_NUMBER	N/A

1.5.4.4 Additional Trade Item Identification List

CodeName	CodeValue
BUYER_ASSIGNED	N/A
INDUSTRY_ASSIGNED	N/A

Business Solution Design

D	
SUPPLIER_ASSIGNED	N/A

1.5.4.5 Allowance Charge List

CodeName	Code-Value
ALLOWANCE_GLOBAL	N/A
CHARGE_GLOBAL	N/A
CONSOLIDATED	N/A
FLAT_RATE	N/A
FREE_GOODS	N/A
FREIGHT_COSTS	N/A
INSURANCE_CHARGE	N/A
LUMP_SUM	N/A
MARKUP_FOR_SMALL_VOLUME_PURCHASES	N/A
PACKING_CHARGES	N/A

1.5.4.6 Allowance or Charge List

CodeName	CodeValue
ALLOWANCE	N/A
CHARGE	N/A

1.5.4.7 Bar Code Type List

CodeName	Code Value
COMPOSITE_COMPONENT_A	N/A
COMPOSITE_COMPONENT_B	N/A
COMPOSITE_COMPONENT_C	N/A
EAN_UCC_13_SYMBOL	N/A
EAN_UCC_14_SYMBOL	N/A
EAN_UCC_8_SYMBOL	N/A
ITF_14_SYMBOL	N/A
RSS_14	N/A
RSS_14_STACKED	N/A
RSS_14_STACKED_OMNIDIRECTIONAL	N/A
RSS_14_TRUNCATED	N/A
RSS_EXPANDED	N/A
RSS_EXPANDED_STACKED	N/A
RSS_LIMITED	N/A
UCC_EAN_128_SYMBOL	N/A
UPC_A_SYMBOL	N/A
UPC_E_SYMBOL	N/A

1.5.4.8 Billed Rate As Quantity Qualifier Type List

CodeName	CodeValue
100_POUNDS_OR_45.3_KILOGRAMS	N/A
CUBIC_FOOT_OR_CUBIC_METRE	N/A
EACH_OR_PIECE	N/A
FLAT_RATE	N/A
FOOT_OR_METRE	N/A
GALLON_OR_LITRE	N/A
LOAD	N/A
MILES_OR_KILOMETRES	N/A
POUND_OR_KILOGRAM	N/A
SHIPPING_UNIT_OR_DESPATCH_UNIT	N/A
SQUARE_YARDS_OR_SQUARE_METRES	N/A

1.5.4.9 Buying Party Identification List

CodeName	CodeValue
MANUFACTURER	N/A
RETAILER	N/A
WAREHOUSE	N/A
WHOLESALE	N/A

1.5.4.10 Collaboration Priority Code List

CodeName	CodeValue
HIGH	N/A
LOW	N/A
MEDIUM	N/A

1.5.4.11 Collect On Delivery Code List

CodeName	CodeValue
REGULAR_COLLECT_ON_DELIVERY	N/A
TAGLESS_COLLECT_ON_DELIVERY	N/A

1.5.4.12 Collect On Delivery Funds Code List

CodeName	Code-Value
----------	------------

Business Solution Design

ALL_SUPPORTED_FUNDS	N/A
CASHIERS_CHECK_MONEY_ORDER_ONLY	N/A
CHECK_CASHIERS_CHECK_MONEY_ORDER_ONL Y	N/A

1.5.4.13 Commodity Code List

CodeName	Code- Value
NATIONAL_MOTOR_FREIGHT_CLASSIFICATIO N	N/A
OIL_INDUSTRY_COMMON_PRODUCT_CODE	N/A
RECEIVERS_COMMODITY_CODE	N/A
SENDERS_COMMODITY_CODE	N/A

1.5.4.14 Communication Channel Code List

CodeName	CodeValue
EMAIL	N/A
TELEFAX	N/A
TELEPHONE	N/A
WEBSITE	N/A

1.5.4.15 Company Identification Format List

CodeName	CodeValue
BUYER_ASSIGNED	N/A
DUNS	N/A
GLN	N/A
SELLER_ASSIGNED	N/A

1.5.4.16 Correction Indicator List

CodeName	CodeValue
BALANCE_DUE_BILLING	N/A
MISCELLANEOUS_BILLING	N/A
PAST_DUE_BILLING	N/A
REBILLING_IGNORE_PREVIOUS_BIL L	N/A

Business Solution Design

1.5.4.17 Data Source Code List

CodeName	CodeValue
BUYER	N/A
SELLER	N/A

1.5.4.18 Date Format List

CodeName	CodeValue
CCYYMMDD	N/A
DDMMCCYY	N/A
DDMMMCCYY	N/A
MMDDCCYY	N/A
MMMDDCCYY	N/A
PERIOD_ID	N/A
XSD_DATE	N/A
XSD_DATE_TIME	N/A

1.5.4.19 Days of the Week List

CodeName	CodeValue
FRIDAY	N/A
MONDAY	N/A
SATURDAY	N/A
SUNDAY	N/A
THURSDAY	N/A
TUESDAY	N/A
WEDNESDAY	N/A

1.5.4.20 Debit Credit Indicator List

CodeName	CodeValue
CREDIT	N/A
DEBIT	N/A

1.5.4.21 Deliver Date Type List

CodeName	CodeValue
ACTUAL_DELIVERY_DATE	N/A
ACTUAL_PICKUP_DATE	N/A
CUSTOMS_RELEASE_DATE	N/A
NOTIFICATION_DATE	N/A
REQUESTED_PICKUP_DATE	N/A

Business Solution Design

SCHEDULED_DELIVERY_DATE|N/A

1.5.4.22 Deliver Party Role List

CodeName	Code-Value
BILL_TO_PARTY	N/A
CONSIGNEE	N/A
DESTINATION_TERMINAL	N/A
ORIGIN_TERMINAL	N/A
PARTY_TO_RECEIVE_FREIGHT_BILL	N/A
PARTY_WHO_SIGNED_DELIVERY_RECEIPT	N/A
SHIP_FROM	N/A
SHIP_TO	N/A
SHIPPER	N/A

1.5.4.23 Deliver Payment Method Code List

CodeName	CodeValue
COLLECT	N/A
CONSIGNEE_BILLING	N/A
PREPAID_BY_CONSIGNOR	N/A
THIRD_PARTY_PAY	N/A

1.5.4.24 Deliver Reference Code List

CodeName	CodeValue
ACCOUNTS_RECEIVABLE_CUSTOMER_ACCOUNT	N/A
AGENTS_SHIPMENT_NUMBER	N/A
APPOINTMENT_NUMBER	N/A
APPROPRIATION_NUMBER	N/A
BILL_OF_LADING_NUMBER	N/A
BOOKING_NUMBER	N/A
CANADIAN_SOCIAL_INSURANCE_NUMBER	N/A
CARRIER_ASSIGNED_PACKAGE_ID	N/A
CARRIERS_REFERENCE_NUMBER_PRO_OR_INVOICE_NUMBER	N/A
CONSIGNEE_INVOICE_NUMBER	N/A
CONSIGNEE_ORDER_NUMBER	N/A
CONSIGNEE_REFERENCE_NUMBER	N/A
COST_ALLOCATION_REFERENCE	N/A
CUSTOMER_ACCOUNT_NUMBER	N/A

Business Solution Design

CUSTOMER_ORDER_NUMBER	N/A
CUSTOMER_REFERENCE_NUMBER	N/A
DATA_RELIABILITY_CODE_NUMBER	N/A
DEALER_ORDER_NUMBER	N/A
DEPARTMENT_NUMBER	N/A
DESPATCH_ADVICE_NUMBER	N/A
EMPLOYERS_IDENTIFICATION_NUMBER	N/A
EQUIPMENT_NUMBER	N/A
FEDERAL_TAXPAYERS_IDENTIFICATION_NUMBER	N/A
FOOD_AND_DRUG_ADMINISTRATION_FDA_PRODUCT_CODE	N/A
FREE_ASTRAY_NUMBER	N/A
GOODS_AND_SERVICE_TAX_REGISTRATION_NUMBER	N/A
INVALID_ACCOUNT_REASON_CODE	N/A
LOAD_NUMBER	N/A
LOAD_PLANNING_NUMBER	N/A
LOCATION_NUMBER	N/A
MANIFEST_KEY_NUMBER	N/A
MASTER_BILL_OF_LADING	N/A
MUTUALLY_DEFINED	N/A
NEXT_AVAILABLE_FLIGHT_JOB_NUMBER	N/A
OFFER_IDENTIFIER_NUMBER	N/A
ORIGINAL_INVOICE_NUMBER	N/A
PACKAGE_NUMBER	N/A
PACKING_LIST_NUMBER	N/A
PART_NUMBER	N/A
PICKUP_REFERENCE_NUMBER	N/A
PORT_CODE	N/A
PRODUCTION_CODE	N/A
PURCHASE_ORDER_ITEM_NUMBER	N/A
PURCHASE_ORDER_NUMBER	N/A
PURCHASE_REQUISITION_NUMBER	N/A
RETURN_MATERIAL_AUTHORIZATION_NUMBER	N/A
RETURNED_GOODS_AUTHORIZATION_NUMBER	N/A
SALESPERSON	N/A
SELLER_INVOICE_NUMBER	N/A
SERIAL_NUMBER	N/A
SERVICE_CHARGE_NUMBER	N/A
SERVICE_REQUEST_NUMBER	N/A
SHIP_FROM_ACCOUNT_NUMBER	N/A
SHIP_NOTICE_MANIFEST_NUMBER	N/A

Business Solution Design

SHIPPER_IDENTIFYING_NUMBER_FOR_SHIPMENT	N/A
SHIPPERS_ACCOUNT_NUMBER	N/A
SHIPPERS_ORDER_INVOICE_NUMBER	N/A
SOCIAL_SECURITY_NUMBER	N/A
SOFTWARE_APPLICATION_NUMBER	N/A
SPECIAL_APPROVAL_NUMBER	N/A
SPLIT_SHIPMENT_NUMBER	N/A
SSCC-18	N/A
SSCC-18_AND_APPLICATION_NUMBER	N/A
STORE_NUMBER	N/A
TERMINAL_RELEASE_NUMBER	N/A
TRACER_ACTION_REQUEST_NUMBER	N/A
TRACKING_NUMBER	N/A
TRANSACTION_REFERENCE_NUMBER	N/A
TRANSPORTATION_CONTROL_NUMBER	N/A
VENDOR_IDENTIFICATION_NUMBER	N/A
WAYBILL_NUMBER	N/A

1.5.4.25 Document Status List

CodeName	CodeValue
COPY	N/A
ORIGINAL	N/A

1.5.4.26 Effective Date List

CodeName	CodeValue
EFFECTIVE_DATE	N/A
EXPIRATION_DATE	N/A
FIRST_ARRIVAL_DATE	N/A
FIRST_ORDER_DATE	N/A
FIRST_SHIP_DATE	N/A
LAST_ARRIVAL_DATE	N/A
LAST_ORDER_DATE	N/A
LAST_SHIP_DATE	N/A

1.5.4.27 Entity Identifier Code List

CodeName	CodeValue
ACTUAL_CONSIGNEE	N/A
INTENDED_CONSIGNEE	N/A

Business Solution Design

UPDATED_CONSIGNEE | N/A |

1.5.4.28 Entity Type List

CodeName	CodeValue
1_BUYER_RECONCILIATION_OF_REQUEST_FOR_PAYMENT	N/A
2_CARRIER_ROUTING_INSTRUCTION	N/A
3_CATALOGUE_ITEM_CONFIRMATION	N/A
4_CATALOGUE_ITEM_LINK	N/A
5_CATALOGUE_ITEM_NOTIFICATION	N/A
6_CATALOGUE_ITEM_PUBLICATION	N/A
7_CATALOGUE_ITEM_REGISTRATION_RESPONSE	N/A
8_CATALOGUE_ITEM_SUBSCRIPTION	N/A
9_CONFIGURE_TO_ORDER	N/A
10_CONFIRMATION_OF_SETTLEMENT_INSTRUCTIONS	N/A
11_CONTROL_TOTAL	N/A
12_DATA_SYNCHRONISATION_DATA_POOL_PROFILE	N/A
13_DATA_SYNCHRONISATION_ERROR	N/A
14_DEBIT_CREDIT_ADVICE	N/A
15_DESPATCH_ADVICE	N/A
16_EANUCC_RESPONSE	N/A
17_EVENT	N/A
18_EXCEPTION_CRITERIA	N/A
19_EXCEPTION_NOTIFICATION	N/A
20_FINANCIAL_INSTITUTION_CONTROL_TOTAL	N/A
21_FORECAST	N/A
22_FORECAST_BULK_DATA	N/A
23_FORECAST_REVISION	N/A
24_FTL_LOAD_TENDER_RESPONSE	N/A
25_FTL_LTL_SHIPMENT_STATUS	N/A
26_FTL_LTL_SHIPMENT_STATUS_INQUIRY	N/A
27_FULL_TRUCKLOAD_FREIGHT_INVOICE	N/A
28_FULL_TRUCKLOAD_LOAD_TENDER	N/A
29_GDSN_EXCEPTION	N/A
30_INVENTORY_ACTIVITY_OR_INVENTORY_STATUS	N/A
31_LESS_THAN_TRUCKLOAD_FREIGHT_INVOICE	N/A
32_LTL_CARRIER_BILL_OF_LADING	N/A
33_MOTOR_FUEL_CARRIER_BILL_OF_LADING	N/A
34_MULTI_SHIP_TO_ORDER	N/A
35_ORDER	N/A
36_ORDER_RESPONSE	N/A
37_PARTY_CONFIRMATION	N/A
38_PARTY_DOCUMENT	N/A

Business Solution Design

39_PARTY_NOTIFICATION	N/A
40_PARTY_PUBLICATION	N/A
41_PARTY_REGISTRATION	N/A
42_PARTY_REGISTRATION_RESPONSE	N/A
43_PARTY_SUBSCRIPTION	N/A
44_PERFORMANCE_HISTORY	N/A
45_PICKUP_NOTIFICATION_LTL	N/A
46_PRICE_BRACKET_DOCUMENT	N/A
47_PRICE_DOCUMENT	N/A
48_PRODUCT_ACTIVITY	N/A
49_PRODUCT_ACTIVITY_BULK_DATA	N/A
50_RECEIVING_ADVICE	N/A
51_REGISTRY_CATALOGUE_ITEM	N/A
52_REPLENISHMENT_PROPOSAL	N/A
53_REPLENISHMENT_REQUEST	N/A
54_REQUEST_FOR_CATALOGUE_ITEM_NOTIFICATION	N/A
55_REQUEST_FOR_PARTY_NOTIFICATION	N/A
56_REQUEST_FOR_PAYMENT	N/A
57_RETAIL_EVENT	N/A
58_SEARCH_REQUEST	N/A
59_SEARCH_RESULT	N/A
60_SETTLEMENT	N/A
61_SIMPLE_INVOICE	N/A
62_SMALL_PACKAGE_CARRIER_FREIGHT_INVOICE	N/A
63_SMALL_PACKAGE_PICKUP_MANIFEST	N/A
64_SPC_SHIPMENT_STATUS	N/A
65_SPC_SHIPMENT_STATUS_INQUIRY	N/A
66_TRADE_ITEM_DOCUMENT	N/A
67_TRADE_ITEM_INFORMATION_REQUEST	N/A
68_TRADE_ITEM_LOCATION_PROFILE	N/A
69_WAREHOUSE_SHIPPING_ORDER	N/A

1.5.4.29 Equipment Type Code List

CodeName	CodeValue
CHASIS	N/A
CONTAINER	N/A
CONTROLLED_TEMPERATURE_TRAILER_REEFER	N/A
DOUBLE_DROP_TRAILER	N/A
FIXED_RACK_DOUBLE_DROP_TRAILER	N/A
FIXED_RACK_FLAT_BED_TRAILER	N/A
FIXED_RACK_SINGLE_DROP_TRAILER_REEFER	N/A
FLAT_BED_TRAILER	N/A

Business Solution Design

HIGH_CUBE_TRAILER	N/A
OPEN_TOP_VAN	N/A
REMOVABLE_SIDE_TRAILER	N/A
SINGLE_DROP_TRAILER	N/A
TRAILER_DRY_FREIGHT	N/A
TRAILER_ELECTRIC_HEAT	N/A
TRAILER_HEATED_INSULATED_VENTILATED	N/A
TRAILER_INSULATED	N/A
TRAILER_NOT_OTHERWISE_SPECIFIED	N/A
TRAILER_PNEUMATIC	N/A
TRAILER_TANK_CHEMICALS	N/A
TRAILER_TANK_FOOD_GRADE_LIQUIDS	N/A
TRAILER_TANK_GAS	N/A
TRUCK_VAN	N/A

1.5.4.30 Exception Status Type Code List

CodeName	Code-Value
EXCEPTION_REASON_ONLY	N/A
EXCEPTION_REASON_WITH_RESOLUTION	N/A
EXCEPTION_REASON_WITH_STATUS	N/A

1.5.4.31 Forecast Purpose Code List

CodeName	CodeValue
ORDER_FORECAST	N/A
SALES_FORECAST	N/A

1.5.4.32 Forecast Type Code List

CodeName	CodeValue
BASE	N/A
PROMOTIONAL	N/A
SEASONAL	N/A
TOTAL	N/A

1.5.4.33 Freight Invoice Payment Method Code List

CodeName	Code-
----------	-------

Business Solution Design

	Value
BANK_ACCOUNT_DEBIT	N/A
COLLECT	N/A
COLLECT_ON_DELIVERY	N/A
CONSIGNEE_BILLING	N/A
CREDIT_CARD	N/A
DEFINED_BY_BUYER_AND_SELLER	N/A
MIXED	N/A
PREPAID_BY_SELLER_OR_CONSIGNOR	N/A
SERVICE_FREIGHT_NO_CHARGE	N/A
THIRD_PARTY_PAY	N/A

1.5.4.34 Location Identification Format List

CodeName	CodeValue
BUYER_ASSIGNED	N/A
DUNS_PLUS_FOUR	N/A
GLN	N/A
SELLER_ASSIGNED	N/A

1.5.4.35 Master Handling Unit of Measure Code List

CodeName	CodeValue
BUNDLE	N/A
CARTON	N/A
PALLET	N/A
PIECES	N/A
SKID	N/A
SLIP_SHEET	N/A

1.5.4.36 Message Reason List

CodeName	CodeValue
01_PRICING_ERROR	N/A
02_ALLOWANCE_CHARGE_ERROR	N/A
03_EXTENSION_ERROR	N/A
04_ITEM_NOT_ACCEPTED_DAMAGED	N/A
05_ITEM_NOT_ACCEPTED_QUALITY	N/A
07_INCORRECT_PRODUCT	N/A
08_SUBSTITUTE_PRODUCT	N/A
09_TERMS_OF_SALE_ERROR	N/A
10_PALLET_CONTAINER_CHARGE_ERROR	N/A

Business Solution Design

11 RETURNS DAMAGE	N/A
12 RETURNS QUALITY	N/A
13 RETURNS DATING	N/A
14 RETURNS PROMOTION	N/A
15 RETURNS RECALL	N/A
18 NOT COMPANY BILL	N/A
19 DUPLICATE BILLING	N/A
20 BALANCE DUE DECLINED	N/A
21 SHIPMENT METHOD OF PAYMENT INCORRECT	N/A
22 WEIGHT ERROR	N/A
24 DISCOUNT	N/A
25 ITEMS NOT ACCEPTED	N/A
26 INVOICE CANCELLED	N/A
27 PRODUCT TRANSFERS SUBJECT TO CHARGEBACK	N/A
29 FEE INCORRECT	N/A
30 DELIVERY CHARGE INCORRECT	N/A
31 PICKUP CHARGE INCORRECT	N/A
32 OVERSIZE PREMIUM INVALID	N/A
33 CURRENCY EXCHANGE INCORRECT	N/A
34 DECLARED VALUE INCORRECT	N/A
35 COMMODITY CODE INCORRECT	N/A
36 SCALE NUMBER INCORRECT	N/A
37 DIMENSIONS INCORRECT	N/A
38 SERVICE INCORRECT	N/A
39 SHIPPER OR CONSIGNEE REFERENCE NUMBER MISSING	N/A
40 ADDRESS INCORRECT	N/A
44 REQUIRED DOCUMENTS MISSING	N/A
45 STALE BILL OVER 180 DAYS OLD	N/A
46 TRANSPORTATION CHARGE INCORRECT	N/A
47 ADVANCE CHARGE INCORRECT	N/A
48 SERVICE CHARGE	N/A
49 PROCESSING CHARGE	N/A
50 LATE CHARGE	N/A
52 CREDIT FOR OVERPAYMENT	N/A
53 REMITTANCE FOR PREVIOUS UNDERPAYMENT	N/A
54 FREIGHT DEDUCTED	N/A
59 ITEM NOT RECEIVED	N/A
60 NO OPEN ITEM ON FILE	N/A
61 NO OPEN ORDER ON FILE	N/A

Business Solution Design

62 MATERIAL OR ITEM DESCRIPTION ERROR	N/A
64 SALE OF PROPERTY	N/A
70 ADVANCED SHIP NOTICE NOT RECEIVED	N/A
71 ADVERTISING ALLOWANCE	N/A
72 AUTHORIZED RETURN	N/A
73 BILL OF LADING NOT RECEIVED	N/A
74 CANCEL OR ADJUST PRIOR CREDIT OR DEBIT ADJUSTME	N/A
75 TOTAL ORDER NOT RECEIVED	N/A
76 CASH DISCOUNT	N/A
78 COMPETITIVE PRICE	N/A
79 COOPERATIVE ADVERTISING	N/A
81 CREDIT AS AGREED	N/A
82 DEFECTIVE ALLOWANCE	N/A
83 EVALUATED RECEIPT SETTLEMENT (ERS) DELIVERY CHARGE	N/A
85 DISTRIBUTION DISCOUNT ALLOWANCE	N/A
86 DUPLICATE PAYMENT	N/A
87 DUPLICATE SHIPMENT	N/A
88 DUTY CHARGE VARIANCE	N/A
89 EARLY BUY ALLOWANCE	N/A
91 ENGRAVING CHARGE	N/A
92 MERCHANDISE NOT ORDERED	N/A
93 FIELD DESTROY	N/A
94 FIXTURES CHARGE	N/A
95 FLOOR STOCK PROTECTION	N/A
96 GOODS TO FOLLOW	N/A
97 HANDLING CHARGE	N/A
98 LABOR CHARGES	N/A
99 LATE SHIPMENT OF GOODS	N/A
A1 LAYOUT OR DESIGN CHARGE	N/A
A3 NEW STORE ALLOWANCE	N/A
A4 NON RECEIPT OF GOODS	N/A
A5 OVERAGE	N/A
A7 PAYMENT ON ACCOUNT	N/A
A8 PROMOTIONAL ALLOWANCE	N/A
A9 PROOF OF DELIVERY NOT RECEIVED	N/A
AH ORIGINATION FEE	N/A
AQ RETURNS OVERSTOCK	N/A
AS RETURNS DISCONTINUED	N/A
AT ACCOUNT LOCATION CLOSED	N/A

Business Solution Design

B1_PROOF_OF_SHIPMENT_NOT_RECEIVED	N/A
B2_REBATE	N/A
B4_REFURBISHING_CHARGE	N/A
B5_REPAIR_OF_GOODS	N/A
B6_REPAY_DISCOUNT	N/A
B7_RESTOCKING_CHARGE	N/A
B8_ROUTING_VIOLATION	N/A
B9_SAMPLES_NOT_RECEIVED	N/A
BA_CANADIAN_GOODS_AND_SERVICES_TAX	N/A
BB_QUEBEC_GOODS_AND_SERVICES_TAX	N/A
BC_CANADIAN_HARMONIZED_GOODS_AND_SERVICES_TAX	N/A
BE_FIXTURE_ALLOWANCE	N/A
BF_RETURN_ALLOWANCE	N/A
BG_BAG_CHARGE	N/A
BH_OPPORTUNITY_BUY	N/A
BI_HANGER_CHARGE	N/A
BJ_INSURANCE_CHARGE	N/A
BK_POSTAGE_CHARGE	N/A
BL_NET_CHECK_RETURNED	N/A
BM_NET_COLLECTION_EXPENSE_(FACTOR)	N/A
BP_NET_CHARGEBACK_OF_CLIENT_RISK_(FACTOR)	N/A
BS_PAID_DURING_PERIOD	N/A
C1_SETTLEMENT_OF_ACCOUNT	N/A
C3_SPECIAL_FINISH	N/A
C4_STOCK_BALANCE	N/A
C6_TESTING_CHARGE	N/A
C8_TICKETING_ERROR	N/A
C9_TICKETING_SERVICE	N/A
CM_COVERED_BY_CREDIT_MEMO	N/A
CU_CHARGE_FOR_UNREQUESTED_SERVICE	N/A
D1_TRANSFER_BETWEEN_ACCOUNTS	N/A
D2_TRANSPORTATION_DIRECT_BILLING	N/A
D3_UNAUTHORIZED_DEDUCTION	N/A
D4_UNAUTHORIZED_PRODUCT	N/A
D5_VOLUME_DISCOUNT	N/A
D8_COUNT_AND_RECOUNT_ALLOWANCE	N/A

Business Solution Design

D9_STORE_STOCK_PRICE_PROTECTION	N/A
E1_RECOUPMENT	N/A
E2_COVERED_BY_DEBIT_MEMO	N/A
E4_WAREHOUSE_STOCK_PRICE_PROTECTION	N/A
E5_INVOICE_PRICE_PROTECTION	N/A
E6_GOODS_AND_SERVICES_TAX_0%_RATE_INTERNATIONAL_DOCUMENTATION WILL_FOLLOW	N/A
E7_GOODS_AND_SERVICES_TAX_DECREASED_DUE_TO_BILLING_ERROR	N/A
E8_GOODS_AND_SERVICES_TAX_INCREASED_DUE_TO_BILLING_ERROR	N/A
E9_ORDER_CANCELLED	N/A
F1_DEFECTIVE	N/A
FA_ANTICIPATION_TAKEN	N/A
GA_FREE_GOODS	N/A
GB_COUPON_RELATED	N/A
GC_MARKET_DEVELOPMENT_FUND_DEDUCTION	N/A
GD_SAMPLES	N/A
GE_SLOTTING_CHARGE	N/A
GF_INVALID	N/A
GG_UNALABLE_MERCHANDISE	N/A
GH_BILLBACK_ALLOWANCE_DEDUCTION	N/A
GJ_UNALABLE_PAYMENTS_DEDUCTION	N/A
GK_SPLIT_COMMISSION_DEDUCTION_BASIS_AMOUNT	N/A
GL_UNRESOLVED_CUSTOMER_DEDUCTION	N/A
GM_SPLIT_COMMISSION_DEDUCTION_COMMISSION_AMOUNT	N/A
GN_GENERAL_ADVANCE	N/A
GR_GUARANTEE	N/A
H1_INFORMATION_FORTHCOMING	N/A
H2_PAYMENT_PREVIOUSLY_SENT	N/A
H3_LOAN_PAID_IN_FULL	N/A
H6_PARTIAL_PAYMENT_REMITTED	N/A
H7_PAYMENT_FORTHCOMING	N/A
H8_BILL_MORTGAGEE	N/A
HD_EXPENSE_PAYMENT	N/A
IA_INVOICE_AMOUNT_DOES_NOT_MATCH_ACCOUNT_ANALYSIS_STATEMENT	N/A

Business Solution Design

J3_PROMISED_ADJUSTMENT_NOT_RECEIVED	N/A
J8_UNABLE_TO_PROCESS	N/A
L1_AUDIT	N/A
L3_PENALTY	N/A
L4_ADMINISTRATIVE_FEES	N/A
L7_MISCELLANEOUS_DEDUCTIONS	N/A
L8_MISCELLANEOUS_CREDITS	N/A
L9_MILITARY_DISTRIBUTION_ADJUSTMENT	N/A
LF_LAWYER_OR_CLAIMANT_ATTORNEY_FEES	N/A
LO_LEDGER_OVERDRAFT_CHARGE	N/A
M2_COMMISSIONS_DEDUCTIONS	N/A
M3_GIFT_CERTIFICATES	N/A
M4_SALARY_DEDUCTION	N/A
MA_MARKETING_ALLOWANCES	N/A
MB_PICKUP_ALLOWANCE	N/A
MD_INCORRECT_PURCHASE_ORDER_NUMBER_ON_BILL_OF_LADING	N/A
ME_PURCHASE_ORDER_NUMBER_NOT_ON_BILL_OF_LADING	N/A
MF_MULTIPLE_PURCHASE_ORDER_NUMBERS_ON_INVOICE	N/A
MG_PURCHASE_ORDER_NUMBER_INCORRECT_ON_INVOICE	N/A
MH_PURCHASE_ORDER_NUMBER_NOT_ON_INVOICE	N/A
MI_TRANSFER_OR_DEBIT_BALANCE	N/A
MJ_TRUCKLOAD_ALLOWANCE	N/A
MK_WAREHOUSE_ALLOWANCE	N/A
MM_INCORRECT_PRODUCT_ID_ON_CARTONS	N/A
MN_INCORRECT_PURCHASE_ORDER_NUMBER_ON_CARTON	N/A
MO_NO_PRODUCT_ID_ON_CARTONS	N/A
MP_NO_PURCHASE_ORDER_NUMBER_ON_CARTON	N/A
MQ_STORAGE_CHARGES	N/A
OL_COURT_ORDERED_LIEN	N/A
PP_QUEBEC_PENSION_PLAN	N/A
PT_PAYMENT	N/A
RB_AGREED_FREIGHT_ALLOWANCE	N/A
RC_AUTHORIZED_AIR_SHIPMENT	N/A
RF_COMMISSION_DISCREPANCY	N/A

Business Solution Design

RG_DIFFERENC_ON_RETURNS	N/A
RH_EARLY_SHIPMENT_OF_GOODS	N/A
RI_EXCESSIVE_PACKAGING_MATERIALS	N/A
RJ_FAILURE_TO_CONSOLIDATE	N/A
RK_FREIGHT_ON_RETURNS_INBOUND_INCORRECT	N/A
RL_FREIGHT_ON_RETURNS_OUTBOUND_INCORRECT	N/A
RM_RETURNED_MATERIAL	N/A
RN_HANDLING_CHARGE_FOR_ITEM_NOT_RECEIVED	N/A
RO_HANDLING_RECEIPT_FOR_NON_RECEIPT_OF_GOODS	N/A
RP_HANDLING_CHARGE_FOR_LATE_ADVANCE_SHIP_NOTICE	N/A
RQ_HANDLING_CHARGE_FOR_SAMPLES_NOT_RECEIVED	N/A
RR_HANDLING_CHARGE_FOR_UNREADABLE_ADVANCE_SHIP_NOT	N/A
RS_INCORRECT_PACKING_ASSORTMENT	N/A
RT_IN_STORE_DECORATION_ALLOWANCE	N/A
RU_INTEREST	N/A
RV_LABEL_PLACEMENT	N/A
RW_MARGIN_CONTRIBUTION	N/A
RX_MARK_DOWN_ALLOWANCE	N/A
RY_MULTIPLE_SHIPMENT_PENALTY	N/A
RZ_OPENING_ORDER_ALLOWANCE	N/A
SA_PAPER_INVOICE_MISSING	N/A
SC_SERVICE_CANCELLED	N/A
SE_PAPER_PACKING_SLIP_MISSING	N/A
SG_PICKUP_CHARGE_OR_ADVANCED_CHARGES	N/A
SH_PRESENTATION_OF_MERCHANDISE_NOT_AS_SPECIFIED	N/A
SI_PURCHASER_SUPPLIED_RAW_MATERIAL	N/A
SJ_RETURNS_FREIGHT_DISCREPANCY	N/A
SK_SALARY_DISCREPANCY	N/A
SM_SHIPPED_PAST_PURCHASE_ORDER_CANCELLATION_DATE	N/A
SN_SHOULD_BE_SHIPPED_COLLECT_BUT_WAS_SHIPPED_PREPAID	N/A

Business Solution Design

SO_SHOULD_BE_SHIPPED_PREPAID_BUT_WAS_SHIPPED_COLLECT	N/A
SR_STORE_CONTEST_ALLOWANCE	N/A
SS_TRADE_DISCOUNT	N/A
ST_UNAUTHORIZED_AIR_SHIPMENT_CHARGEBACK_IS_THE_DIFFERENCE_BETWEEN_AIR_AND_GROUND	N/A
SU_UNAUTHORIZED_AIR_SHIPMENT_PARTIAL_FREIGHT_CHARGEBACK	N/A
SW_UNAUTHORIZED_OR_INCORRECT_CARRIER	N/A
SX_VOLUME_BREAK_CHARGEBACK	N/A
SY_WEIGHT_BREAK_CHARGEBACK	N/A
UB_UNCOLLECTED_BALANCE_CHARGE_REVERSED	N/A
W6_SAFETY_VIOLATIONS	N/A

1.5.4.37 Metric Type Code List

CodeName	CodeValue
FILL_RATE	N/A
FORECAST_ACCURACY	N/A
GROSS_MARGIN	N/A
IN_STOCK	N/A
ON_TIME_DELIVERY	N/A
SUPPLY	N/A

1.5.4.38 Package Status Activity Type Code List

CodeName	CodeValue
DELIVERY	N/A
EXCEPTION	N/A
INTERMEDIATE	N/A
PICKUP	N/A

1.5.4.39 Payment Format List

CodeName	CodeValue
CCD	N/A
CCP	N/A
CTX	N/A
PPD	N/A
PPP	N/A

Business Solution Design

1.5.4.40 Payment Method List

CodeName	CodeValue
BANK_CHEQUE	N/A
BANK_GIRO	N/A
BANKERS_DRAFT	N/A
BOOKENTRY_CREDIT	N/A
BOOKENTRY_DEBIT	N/A
BOP	N/A
CASH	N/A
CERTIFIED_CHEQUE	N/A
CHEQUE	N/A
CREDIT_CARD	N/A
DEBIT_CARD	N/A
ELECTRONIC_CREDIT_ACH	N/A
ELECTRONIC_DEBIT_ACH	N/A
FED_WIRE_NON_REPETITIVE	N/A
FED_WIRE_REPETITIVE	N/A
INTERNATIONAL_WIRE	N/A
LETTER_OF_CREDIT	N/A
POSTGIRO	N/A
WIRE_TRANSFER_CREDIT	N/A
WIRE_TRANSFER_DEBIT	N/A

1.5.4.41 Payment Terms Event List

CodeName	CodeValue
AFTER_DATE_OF_DELIVERY	N/A
ANTICIPATED_DELIVERY_DATE	N/A
DATE_INVOICE_RECEIVED	N/A
DATE_OF_DELIVERY_TO_SITE	N/A
DATE_OF_INVOICE	N/A
DATE_OF_SHIPMENT_AS_EVIDENCED_BY_TRANSPORT_DOCUMENTS	N/A
EFFECTIVE_DATE	N/A
INVOICE_TRANSMISSION_DATE	N/A
RECEIPT_OF_GOODS	N/A

1.5.4.42 Payment Terms Type List

CodeName	CodeValue
BASIC_NET	N/A
BASIC_DISCOUNT_OFFERED	N/A
DEFERRED	N/A

Business Solution Design

DISCOUNT	N/A
DISCOUNT_AFTER_DEDUCTING_FREIGHT	N/A
DISCOUNT_NOT_APPLICABLE	N/A
ELECTIVE	N/A
END_OF_MONTH	N/A
EXTENDED	N/A
FIXED_DATE	N/A
INSTANT	N/A
MIXED	N/A
NO_CHARGE	N/A
PAYMENT_BY_INSTALLMENT	N/A
PREVIOUSLY_AGREED_UPON	N/A
PROXIMO	N/A
VALUTA	N/A

1.5.4.43 Price Date Type List

CodeName	CodeValue
ARRIVAL_DATE	N/A
ORDER_DATE	N/A
SHIP_DATE	N/A

1.5.4.44 Quantity Identification List

CodeName	CodeValue
IN_TRANSIT	N/A
ON_HAND	N/A
ON_HOLD	N/A
TO_BE_DELIVERED	N/A
TO_BE_DESPATCHED	N/A
TO_BE_PRODUCED	N/A

1.5.4.45 Rate Qualifier Type List

CodeName	CodeValue
EACH_OR_PER_PIECE	N/A
FLAT_RATE	N/A
MINIMUM	N/A
PER_CUBIC_FOOT_OR_PER_CUBIC_METRE	N/A
PER_DESPATCH_UNIT	N/A
PER_GALLON_OR_PER_LITRE	N/A
PER_HUNDRED_OF_BASIC_UNIT	N/A

Business Solution Design

PER_LOAD	N/A
PER_MILE_OR_PER_KILOMETRE	N/A
PER_SHIPMENT	N/A
PER_SQUARE_YARD_OR_PER_SQUARE_METRE	N/A

1.5.4.46 Residential Code List

CodeName	CodeValue
BUSINESS_DELIVERY	N/A
RESIDENTIAL_DELIVERY	N/A

1.5.4.47 Response Status List

CodeName	CodeValue
ACCEPTED	N/A
MODIFIED	N/A
REJECTED	N/A

1.5.4.48 Routing Number Type List

CodeName	CodeValue
01_ABA_TRANSIT_ROUTING_NUMBE R	N/A
02_SWIFT_IDENTIFICATION	N/A
03_CHIPS	N/A
04_CANADIAN_BANK	N/A

1.5.4.49 Scan Activity Code List

CodeName	CodeValue
AGENT_SCAN	N/A
AIR_TRANSIT_SCAN	N/A
ARRIVAL	N/A
CANCEL_UNLOAD	N/A
CANCELLED_ARRIVAL	N/A
CANCELLED_DEPARTURE	N/A
DELETED_EXCEPTION	N/A
DELIVERY_INTERNATIONAL	N/A
DELIVERY_LEFT_AT_CUSTOMERS_LOCATION	N/A
DELIVERY_PACKAGE_DRIVER_RELEASED	N/A

Business Solution Design

DELIVERY_PACKAGE_RELEASE_NUMBER	N/A
DELIVERY_PACKAGE_REPORTED_PICKED_UP	N/A
DELIVERY_SIGNATURE_OBTAINED	N/A
DELIVERY_SIGNED_DELIVERY_NOTICE	N/A
DEPARTURE_SCAN	N/A
DESTINATION_SCAN	N/A
DRIVER_LOAD	N/A
EXCEPTION	N/A
EXPORT_SCAN	N/A
HUB_SCAN	N/A
IMPORT_SCAN	N/A
LOCATION_SCAN_OR_ORIGIN_SCAN	N/A
PICKUP_SCAN	N/A
UNLOAD_SCAN	N/A
UPDATED_ARRIVAL	N/A
UPDATED_DEPARTURE	N/A
UPDATED_EXCEPTION	N/A
WAREHOUSE_SCAN	N/A

1.5.4.50 Service Level Code List

CodeName	CodeValue
AUTHORIZED_RETURN_SERVICE	N/A
CONSIGNEE_BILLING_SERVICE	N/A
DELIVERY_CONFIRMATION	N/A
EXPEDITED_SERVICE	N/A
EXPEDITED_SERVICE_WORLDWIDE	N/A
EXPRESS_SERVICE	N/A
EXPRESS_SERVICE_PLUS	N/A
GROUND	N/A
GROUND_CX_EXPRESS_SERVICE	N/A
MULTIWEIGHT	N/A
MUTUALLY_DEFINED	N/A
NEXT_DAY_AIR	N/A
NEXT_DAY_PM	N/A
NEXT_MORNING	N/A
PRIMARY_SERVICE_AREA_NEXT_DAY_BY_10:30_AM	N/A
PRIMARY_SERVICE_AREA_NEXT_DAY_BY_5:00_PM	N/A
SAME_DAY	N/A
SATURDAY	N/A

Business Solution Design

SATURDAY_PICKUP	N/A
SECOND_DAY_AIR	N/A
SECOND_MORNING	N/A
STANDARD_GROUND_HUNDRED_WEIGHT	N/A
STANDARD_SERVICE	N/A
THREE_DAY_SERVICE	N/A

1.5.4.51 Settlement List

CodeName	CodeValue
BILL_BACK	N/A
CHARGE_TO_BE_PAID_BY_CUSTOME R	N/A
CHARGE_TO_BE_PAID_BY_VENDOR	N/A
CREDIT_CUSTOMER_ACCOUNT	N/A
ITEM_ACCRUALS	N/A
OFF_INVOICE	N/A
VENDOR_ACCRUALS	N/A
VENDOR_CHECK	N/A

1.5.4.52 Shipment Exception Code List

CodeName	CodeValue
ALL_SHORT	N/A
DAMAGED	N/A
ENTIRE_SHIPMENT_REFUSE D	N/A
LOST_OR_STOLEN	N/A
OVERAGE	N/A
PARTIAL_SHIPMENT	N/A
WRONG_PRODUCT	N/A

1.5.4.53 Shipment Special Handling Code List

CodeName	CodeValue
AM_DELIVERY_REQUIREMENT	N/A
BLIND_SHIPMENT	N/A
DEFERRED_DELIVERY	N/A
DISPOSE_OF_RESIDUE_HEEL	N/A
DO_NOT_BREAK_DOWN	N/A
DO_NOT_FREEZE	N/A
DO_NOT_SPLIT_SHIPMENT	N/A
DO_NOT_STACK	N/A

Business Solution Design

DROP_OFF_DELIVERY	N/A
DROP_YARD	N/A
EXCLUSIVE_USE_OF_VEHICLE	N/A
EXPEDITED_SERVICE	N/A
EXTRA_DRIVER	N/A
FRAGILE_HANDLE_WITH_CARE	N/A
GUARANTEED	N/A
HEAT	N/A
HEAT_IN_TRANSIT	N/A
HEAT_SPECIAL	N/A
HEAT_WITH_STEAM	N/A
INSIDE_PICKUP	N/A
KEEP_MATERIAL_DRY	N/A
LOAD_ON_TOP_OF_RESIDUE_HEEL	N/A
LOADED_TO_FULL_VISIBLE_CAPACITY	N/A
NEXT_DAY_DELIVERY	N/A
NOTIFY_CONSIGNEE_BEFORE_DELIVERY	N/A
PERISHABLE	N/A
PM_DELIVERY_REQUIRED	N/A
PROTECT_FROM_HEAT	N/A
REFRIGERATED	N/A
RESIDENTIAL_DELIVERY	N/A
ROUND_TRIP_SERVICE	N/A
SECOND_DAY_DELIVERY	N/A
SECURITY_SIGNATURE_SERVICE	N/A
SINGLE_SHIPMENT	N/A
TEMPERATURE_CONTROL	N/A
TOP_FREIGHT_ONLY	N/A

1.5.4.54 Shipment Status Code List

CodeName	CodeValue
ARRIVED_AT_CUSTOMS	N/A
ARRIVED_AT_DELIVERY_LOCATION	N/A
ARRIVED_AT_DELIVERY_LOCATION_LOADING_DOCK	N/A
ARRIVED_AT_PICKUP_LOCATION	N/A
ARRIVED_AT_PICKUP_LOCATION_LOADING_DOCK	N/A
ARRIVED_AT_TERMINAL_LOCATION	N/A
ATTEMPTED_DELIVERY	N/A
AVAILABLE_FOR_DELIVERY	N/A

Business Solution Design

CARRIER_DEPARTED_DELIVERY_LOCATION	N/A
CARRIER_DEPARTED_PICKUP_LOCATION_WITH_SHIPMENT	N/A
COMPLETED_LOADING_AT_PICKUP_LOCATION	N/A
COMPLETED_SHIPMENT	N/A
COMPLETED_UNLOADING_AT_DELIVERY_LOCATION	N/A
CONNECTING_LINE_OR_CARTAGE_PICKUP	N/A
DELIVER_NO_EARLIER_THAN_DATE_AND_OR_TIME	N/A
DELIVER_NO_LATER_THAN_DATE_AND_OR_TIME	N/A
DELIVERED_TO_CONNECTING_LINE	N/A
DELIVERY_APPOINTMENT_DATE_AND_OR_TIME	N/A
DELIVERY_APPOINTMENT_SECURED_ON_THIS_DATE_OR_TIME	N/A
DELIVERY_NOT_COMPLETED	N/A
DEPARTED_TERMINAL_LOCATION	N/A
DIVERTED_TO_AIR_CARRIER	N/A
EN_ROUTE_TO_DELIVERY_LOCATION	N/A
ESTIMATED_DATE_AND_OR_TIME_OF_ARRIVAL_AT_CONSIGNEE	N/A
ESTIMATED_DELIVERY	N/A
ESTIMATED_DELIVERY_APPOINTMENT_DATE_AND_OR_TIME	N/A
ESTIMATED_TO_ARRIVE_AT_CARRIER_TERMINAL	N/A
ESTIMATED_TO_DEPART_TERMINAL_LOCATION	N/A
FINAL_PART_OF_PARTIAL_SHIPMENT_DELIVERED_TO_CUSTOM	N/A
IN_GATE	N/A
LOADED_ON_TRUCK	N/A
LOADING	N/A
ONLY_A_PORTION_OF_HANDLING_UNITS_FOR_SHIPMENT_DELI	N/A
OUT_GATE	N/A
PAPERWORK_RECEIVED_DID_NOT_RECEIVE_SHIPMENT_OR_EQ	N/A
U	N/A
PARTIAL_SHIPMENT	N/A
PICKUP_APPOINTMENT_DATE_AND_OR_TIME	N/A

Business Solution Design

PICKUP_APPOINTMENT_SECURED_ON_DATE_AND_OR_TIME	N/A
PICKUP_NO_EARLIER_THAN_DATE_AND_OR_TIME	N/A
PICKUP_NO_LATER_THAN_DATE_AND_OR_TIME	N/A
RAIL_ARRIVAL_AT_DESTINATION_INTERMODAL_RAMP	N/A
RAIL_DEPARTURE_FROM_ORIGIN_INTERMODAL_RAMP	N/A
RECEIVED_FROM_PRIOR_CARRIER	N/A
REFUSED_BY_CONSIGNEE	N/A
SHIPMENT_ACKNOWLEDGED	N/A
SHIPMENT_CANCELLED	N/A
SHIPMENT_DAMAGED	N/A
SHIPMENT_DELAYED	N/A
SHIPMENT_HAS_BEEN_RECONSIGNEED	N/A
SHIPMENT_RETURNED_TO_SHIPPER	N/A
STORAGE_IN_TRANSIT	N/A
TENDERED_FOR_DELIVERY	N/A
TRAILER_CLOSED_OUT	N/A
TRAILER_SPOTTED_AT_CONSIGNEES_LOCATION	N/A
US_CUSTOMS_HOLD_AT_IN_BOND_LOCATION	N/A

1.5.4.55 Shipment Status Reason Code List

CodeName	CodeValue
ACCIDENT	N/A
ADDRESS_CORRECTED_DELIVERY_ATTEMPTED	N/A
ALTERNATE_CARRIER_DELIVERED	N/A
AWAITING_EXPORT	N/A
BORDER_CLEARANCE	N/A
CARRIER_DISPATCH_ERROR	N/A
CARRIER_KEYING_ERROR	N/A
CARTAGE_AGENT	N/A
CASH_NOT_AVAILABLE_FROM_CONSIGNEE	N/A
CIVIL_EVENT_RELATED_DELAY	N/A
COLLECT_ON_DELIVERY_REQUIRED	N/A
CONSIGNEE_CLOSED	N/A
CONSIGNEE_RELATED	N/A

Business Solution Design

CREDIT_HOLD	N/A
CUSTOMER_REQUESTED_FUTURE_DELIVERY	N/A
CUSTOMER_STRIKE	N/A
CUSTOMER_VACATION	N/A
CUSTOMER_WANTED_EARLIER_DELIVERY	N/A
CUSTOMS_IMPORT_OR_EXPORT	N/A
DAMAGED_REWRAPPED_IN_HUB	N/A
DELIVERY_SHORTAGE	N/A
DRIVER_NOT_AVAILABLE	N/A
DRIVER_RELATED	N/A
EXCEEDS_SERVICE_LIMITATIONS	N/A
FAILED_TO_RELEASE_BILLING	N/A
FLAT_CAR_SHORTAGE	N/A
HELD_FOR_CONSIGNEE	N/A
HELD_FOR_FULL_CARRIER_LOAD	N/A
HELD_FOR_PAYMENT	N/A
HELD_FOR_PROTECTIVE_SERVICE	N/A
HELD_PENDING_APPOINTMENT	N/A
HELD_PER_SHIPPER	N/A
HOLD_DUE_TO_CUSTOMS_DOCUMENTATION_PROBLEMS	N/A
HOLIDAY_CLOSED	N/A
IMPROPER_INTERNATIONAL_PAPERWORK	N/A
IMPROPER_UNLOADING_FACILITY_OR_EQUIPMENT	N/A
INCORRECT_ADDRESS	N/A
INDIRECT_DELIVERY	N/A
INSUFFICIENT_DELIVERY_TIME	N/A
INSUFFICIENT_PICKUP_TIME	N/A
INSUFFICIENT_TIME_TO_COMPLETE_DELIVERY	N/A
INTERNATIONAL_NON_CARRIER_DELAY	N/A
LOAD_SHIFTED	N/A
MECHANICAL_BREAKDOWN	N/A
MIS_SORT	N/A
MISSED_DELIVERY	N/A
MISSED_PICKUP	N/A
MISSING_DOCUMENTS	N/A
NO_REQUESTED_ARRIVAL_DATE_PROVIDE_BY_SHIPPER	N/A

Business Solution Design

NO_REQUESTED_ARRIVAL_TIME_PROVIDED_BY_SHIPPER	N/A
NON_EXPRESS_CLEARANCE_DELAY	N/A
NORMAL_APPOINTMENT	N/A
NORMAL_STATUS	N/A
OTHER	N/A
OTHER_CARRIER_RELATED	N/A
PAST_CUTOFF_TIME	N/A
PRE_ARRANGED_APPOINTMENT	N/A
PREVIOUS_STOP	N/A
PROCESSING_DELAY	N/A
PRODUCTION_FALLDOWN	N/A
RAILROAD_FAILED_TO_MEET_SCHEDULE	N/A
RECEIVING_TIME_RESTRICTED	N/A
RECIPIENT_UNAVAILABLE_DELIVERY_DELAYED	N/A
RECONSIGNED	N/A
REFUSED_BY_CUSTOMER	N/A
RESTRICTED_ARTICLES_UNACCEPTABLE	N/A
RETURNED_TO_SHIPPER	N/A
ROAD_CONDITIONS	N/A
SHIPMENT_OVERWEIGHT	N/A
SHIPPER_RELATED	N/A
SUSPENDED_AT_CUSTOMER_REQUEST	N/A
TRACTOR_CONVENTIONAL_NOT_AVAILABLE	N/A
TRACTOR_WITH_SLEEPER_CAR_NOT_AVAILABLE	N/A
TRAILER_CLASS_NOT_AVAILABLE	N/A
TRAILER_NOT_AVAILABLE	N/A
TRAILER_NOT_USABLE_DUE_TO_PRIOR_PRODUCT	N/A
TRAILER_VOLUME_NOT_AVAILABLE	N/A
TRAIN_DERAILMENT	N/A
TRAP_FOR_CUSTOMER	N/A
UNABLE_TO_CONTACT_RECIPIENT_FOR_BROKER_INFORMATION	N/A
UNABLE_TO_LOCATE	N/A
WAITING_FOR_CUSTOMER_PICKUP	N/A
WAITING_FOR_CUSTOMER_SPECIFIED_CARRIER	N/A
WAITING_INSPECTION	N/A

Business Solution Design

WAITING_SHIPPING_INSTRUCTIONS	N/A
WEATHER_OR_NATURAL_DISASTER_RELATED	N/A

1.5.4.56 Source Code List

CodeName	CodeValue
EANCOM	N/A
EANUCC	N/A
X12	N/A

1.5.4.57 Supplying Party Identification List

CodeName	CodeValue
MANUFACTURER	N/A
MATERIAL_SUPPLIER	N/A
WAREHOUSE	N/A
WHOLESALE	N/A

1.5.4.58 Time Format List

CodeName	CodeValue
DAYS	N/A
MONTHS	N/A
WEEKS	N/A

1.5.4.59 Transportation Method Type Code List

CodeName	CodeValue
AIR	N/A
AIR_CHARTER	N/A
AIR_EXPRESS	N/A
AIR_FREIGHT	N/A
BEST_WAY_SHIPPERS_OPTION	N/A
BOOK_POSTAL	N/A
BUS	N/A
CAB	N/A
CONSOLIDATION	N/A
CONTRACT_CARRIER	N/A
CUSTOMER_PICKUP	N/A
CUSTOMER_PICKUP_OR_CUSTOMERS_EXPENSE	N/A
EXPEDITED_TRUCK	N/A

Business Solution Design

GEOGRAPHIC_RECEIVING	N/A
GEOGRAPHIC_RECEIVING_SHIPPING	N/A
GEOGRAPHIC_SHIPPING	N/A
INLAND_WATERWAY	N/A
INTERMODAL_PIGGYBACK	N/A
LESS_THAN_TRUCK_LOAD	N/A
MOTOR	N/A
MOTOR_COMMON_CARRIER	N/A
MOTOR_FLATBED	N/A
MOTOR_PACKAGE_CARRIER	N/A
MOTOR_TRUCKLOAD	N/A
MOTOR_VAN	N/A
MUTUALLY_DEFINED	N/A
OCEAN	N/A
PARCEL_POST	N/A
PIPELINE	N/A
POOL_TO_POOL	N/A
POOLED_AIR	N/A
POOLED_PIGGYBACK	N/A
POOLED_RAIL	N/A
POOLED_TRUCK	N/A
PRIVATE_CARRIER	N/A
PRIVATE_PARCEL_SERVICE	N/A
PRIVATE_VESSEL	N/A
RAIL	N/A
ROADTRAILER	N/A
SEA_AIR	N/A
STEAM_SHIP	N/A
SUPPLIER_TRUCK	N/A

1.5.4.60 Truckload Special Service Code List

CodeName	CodeValue
CANADIAN_CUSTOMS_SELF_ASSESSMENT	N/A
CARRIER_LOAD_AND_COUNT	N/A
CARRIER_UNLOAD	N/A
CONSIGNEE_UNLOAD	N/A
DELIVERY	N/A
DRIVER_ASSISTED_UNLOADING	N/A
DROP_AND_HOOK_RECEIVING	N/A
DROP_DOCK	N/A
DROP_YARD	N/A
EXPEDITED_SERVICE	N/A

Business Solution Design

INSIDE_DELIVERY	N/A
INSIDE_PICKUP	N/A
LIFT_GATE	N/A
LOADING_SERVICE	N/A
PALLETIZING	N/A
RESIDENTIAL_DELIVERY	
SHIPPER_LOAD_AND_COUNT	N/A
SHIPPER_LOAD_CARRIER_COUNT	N/A
SHIPPER_LOAD_CONSIGNEE_UNLOAD	N/A
SLIP_SHEET_TRUCK	N/A
TANK_WASH_REQUIRED	N/A
TEMPERATURE_PROTECTION	N/A
THIRD_PARTY_PALLETS	N/A

1.5.4.61 Weight Type List

CodeName	CodeValue
ACTUAL_NET_WEIGHT	N/A
BILLED_WEIGHT	N/A
DEFICIT_WEIGHT	N/A
DIMENSIONAL_WEIGHT	N/A
GROSS_WEIGHT	N/A
MINIMUM_WEIGHT	N/A
MUTUALLY_DEFINED_WEIGHT	N/A
PALLET_WEIGHT	N/A
SHIPPERS_WEIGHT	N/A
STATE_WEIGHT	N/A
TARE_WEIGHT	N/A
THEORETICAL_WEIGHT	N/A

1.6 Business Document Example

Not Applicable

1.7 Implementation Considerations

Not Applicable

Business Solution Design

1.8 Testing

Not Applicable

1.8.1 Pass / Fail Criteria

Not Applicable

Number	Test Criteria	Related Requirement	Design Element	Pass Criteria	Fail Criteria
1					
2					
3					

1.8.2 Test Data

Not Applicable

1.9 Appendices

Class Diagrams are referenced in Chapter 3 and Chapter 4

Business Solution Design

1.10 Summary of Changes

(Details changes to BMS for each version by BMS Section)

Change	BMS Version	Associated CR Number
<p>Section 3.5.3 Trade Item Identification</p> <p>Renamed Class</p> <ul style="list-style-type: none"> FROM:CommonAdditionalTradeItemIdentification TO : AdditionalTradeItemIdentification <p>Deleted role name +additionalTradeItemIdentification as the revised class name defaults to the same name.</p>	0.1.2	For consistency to Party Identification structure.
<p>Section 3.4.1 Extended Data Type</p> <p>Renamed Attributes in Class Character</p> <ul style="list-style-type: none"> Attribute FROM: character Attribute TO : characterString <p>Class TimeZone</p> <ul style="list-style-type: none"> Attribute FROM: timeZone Attribute TO : timeZoneDesignator <p>Class Version</p> <ul style="list-style-type: none"> Attribute FROM: version Attribute TO : versionIdentification 	0.1.2	<p>To differentiate the class name and attribute name.</p> <p>Helps to avoid the duplicate data element names in our standards.</p>
Removed Section 4.1 and 4.1.1 Application Receipt Acknowledgment	0.1.2	Removed as ARA is a message and is contained in it's own BRD P4CL: 4844 BRD Ver: 0.41.2
Finished Plan Common section 4.7 to 4.7.6	0.1.2	Finished the remaining balance of 2.0 publication common library
<p>Section 3.2.1. Amount</p> <p>Renamed Attribute in Class Character and corrected dataType Typo</p> <p>Attribute FROM: currencyISOCode : ISO4217Code</p> <p>Attribute TO: currencyCode : ISO4217_Code</p>	0.1.3	Avoid duplicate element name in message.

Business Solution Design

Change	BMS Version	Associated CR Number
Corrected data Type Typo in following classes and section Class: Description (3.2.3.) Class: LongDescription (3.2.4) Attribute FROM: language : ISO639Code Attribute TO : language : ISO639_Code:	0.1.3	
Renamed class BinarySignature (4.2.3.) FROM: BinarySignature TO : BinarySignatureInformation	0.1.3	Avoid duplicate element name in message.
Change in role name to match BRD. Order Logistical Information (4.4.1) OrderLogisticalDateGroup associated to LogisticalDate Role FROM: requestedDeliveryDateUltimateConsignee Role TO : requestedDeliveryDateAtUltimateConsignee	0.1.3	Consistency and matches the BRD requirements.
Section 4.9.2 Name And Address Renamed Attribute in Class NameAndAddress Attribute FROM: currencyISOCode : ISO4217_Code Attribute TO : currencyCode : ISO4217_Code	0.1.3	Avoid duplicate element name in message.
Section 4.11.1 Allowance Charge Change in role name AllowanceCharge associated to MultiDescription Role FROM: description Role TO : allowanceChargeDescription	0.1.3	Avoid duplicate element name in message.
Section 3.5.2 Party Identification Change attribute name in AdditionalPartyIdentification Attribute FROM: additionalPartyIdentification Attribute TO : additionalPartyIdentificationValue	0.1.4	Avoid duplicate element name
Added code list to common library in section 1.5.4.	0.1.4	Added code list

Business Solution Design

Change	BMS Version	Associated CR Number
<p>Updated Deliver Reference Code List added following additional code values</p> <p>ACCOUNTS_RECEIVABLE_CUSTOMER_ACCOUNT AGENTS_SHIPMENT_NUMBER APPROPRIATION_NUMBER DEALER_ORDER_NUMBER EMPLOYERS_IDENTIFICATION_NUMBER FEDERAL_TAXPAYERS_IDENTIFICATION_NUMBER FOOD_AND_DRUG_ADMINISTRATION_FDA_PRODUCT_CODE INVALID_ACCOUNT_REASON_CODE LOCATION_NUMBER MANIFEST_KEY_NUMBER NEXT_AVAILABLE_FLIGHT_JOB_NUMBER PACKAGE_NUMBER PART_NUMBER PORT_CODE PRODUCTION_CODE PURCHASE_ORDER_ITEM_NUMBER PURCHASE_REQUISITION_NUMBER SALESPERSON SERIAL_NUMBER SERVICE_REQUEST_NUMBER SOCIAL_SECURITY_NUMBER SOFTWARE_APPLICATION_NUMBER VENDOR_IDENTIFICATION_NUMBER</p>	0.1.5	Updated Code List
<p>Replaced existing Exception Status Type Code List with the following values</p> <p>EXCEPTION_REASON_ONLY EXCEPTION_REASON_WITH_RESOLUTION EXCEPTION_REASON_WITH_STATUS</p>	0.1.5	Updated Code List
<p>Document Class: 3.1.2. For Datatype replaced Version=2.0 to</p>	0.1.6.	Update

2 XML Technical Solution ITRG Packet

The Technical Representation of the Business process is documented in a Technical Solution ITRG Packet containing all supplemental XML artefacts and is used by the Information Requirements Group (ITRG) to evaluate the solution. Upon approval from the Information Technical Requirements Group (ITRG), the Technical Solution ITRG Packet is updated to the Technical Solution Implementers Packet and published with the Business

Message Standard at:

http://www.ean-ucc.org/global_smp/ean.ucc_standards.htm.

Technical Solution ITRG Packet Content:

- Business Message Standard (BMS)
- ITRG Review Packet
 - Style Sheet: This HTML has been created using a Style Sheet that is a visual representation of the data. It is not an actual Style Sheet, but an example of what a Style Sheet may look like.
 - Instance File: The Instance File is an example of what the schema may look like when it includes live data. This can be used as comparison to a completed schema and can serve as a point of reference for development.
 - Technical Level GDD Report

Technical Solution Implementers Packet Content:

Contains all the message specific.XSD files required to implement

Example:

- AS2Envelope
- Command.xsd
- DocumentCommand.xsd
- Proxy.xsd
- ComponentLibrary.xsd

Both the Business Message Standard and the Implementers Packet are available during the ITRG Review Period in the working documents section of the ITRG eRoom:

http://eroom.uncouncil.org/eRoom/facility/InformationTechnicalAssessmentGroupITAG/0_14f7

All documents for review will be in this folder listed by name of the Change Request and Change Request Number. The Business Message Standard is not open for review, but offered as the basis for determining the suitability of the technical solutions.

This eRoom may be accessed by using the following User Name and Password:

User Name: guest

Password: guest

3 Common Library Common Components

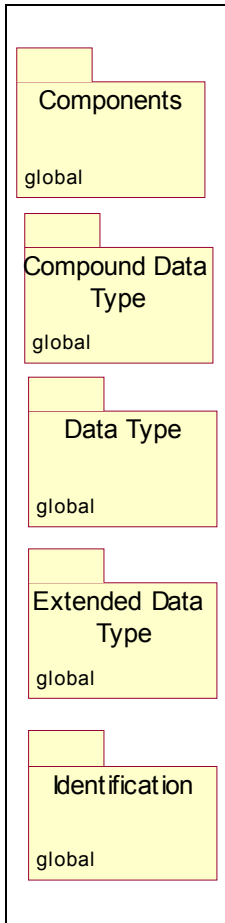

3.1 Package Overview: Components

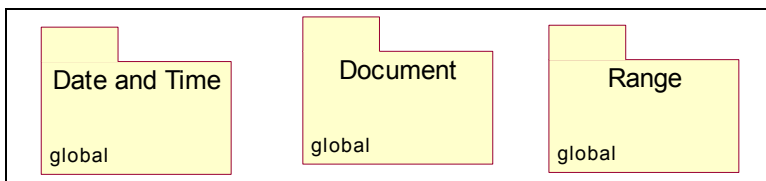

3.1.1 Class Diagram: Date and Time

Common Components: Components: Date and Time

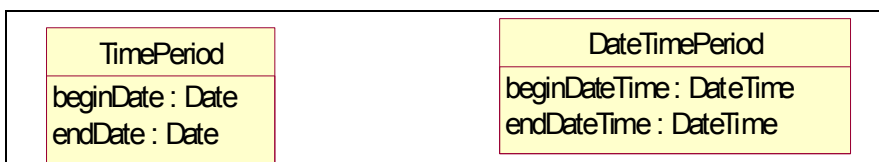

3.1.2 Class Diagram: Document

Common Components: Components: Document

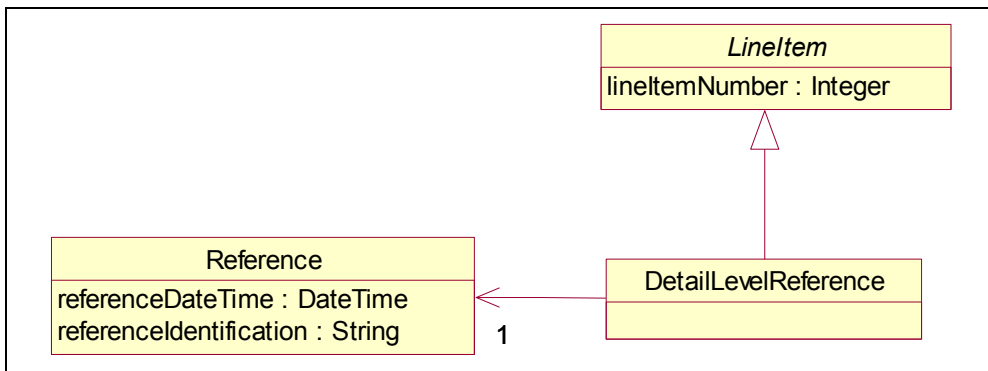
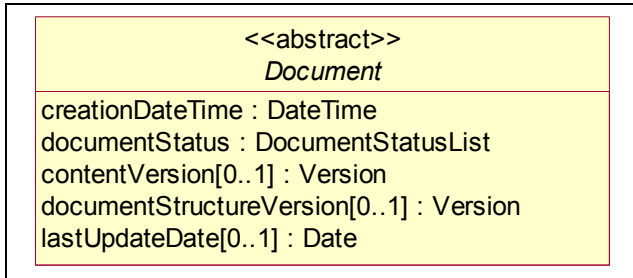

3.1.3 Class Diagram: Range

Common Components: Components: Range

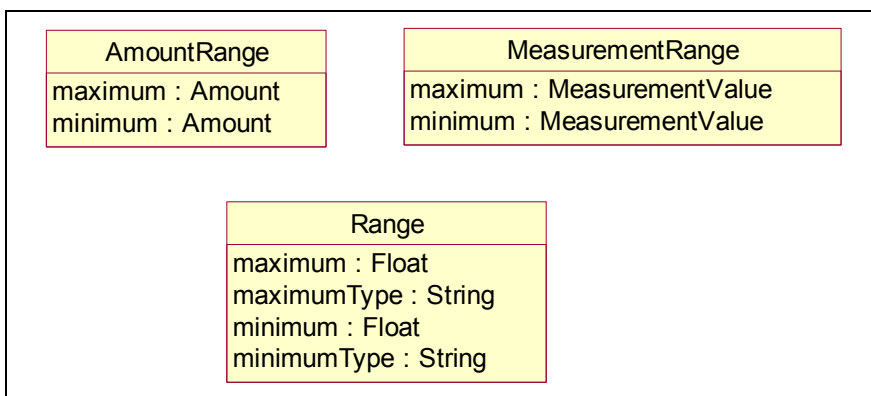

3.2 Package Overview: Compound Data Type

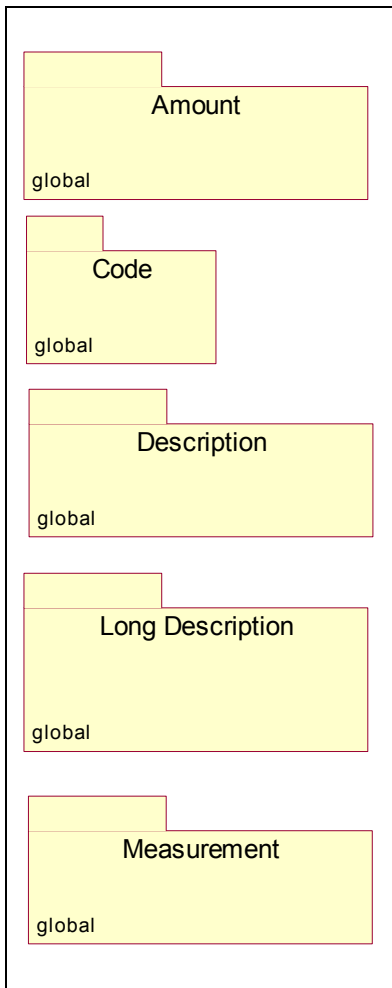

3.2.1 Class Diagram: Amount

Common Components: Compound Data Type: Amount

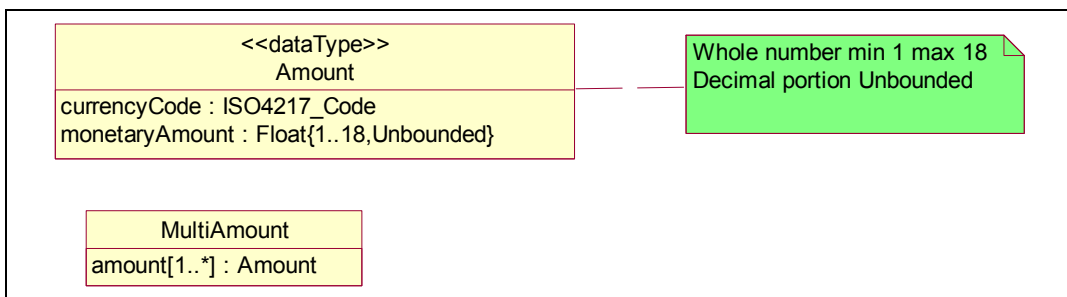

3.2.2 Class Diagram: Code

Common Components: Compound Data Type: Code

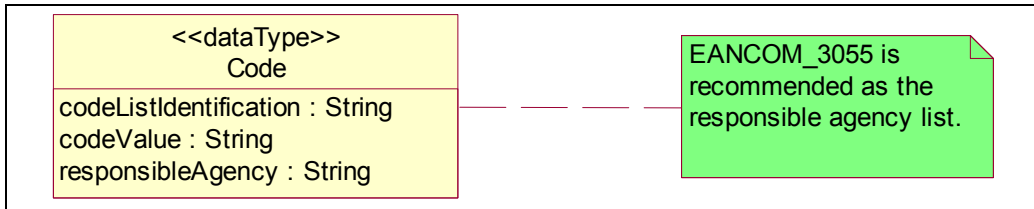

3.2.3 Class Diagram: Description

Common Components: Compound Data Type: Description

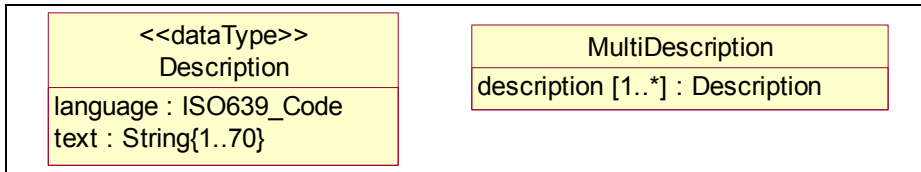

3.2.4 Class Diagram: Long Description

Common Components: Compound Data Type: Long Description

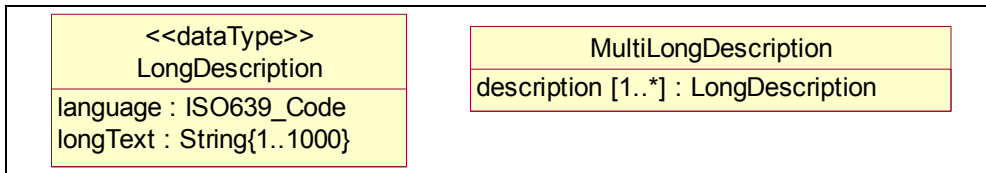

3.2.5 Class Diagram: Measurement

Common Components: Compound Data Type: Measurement

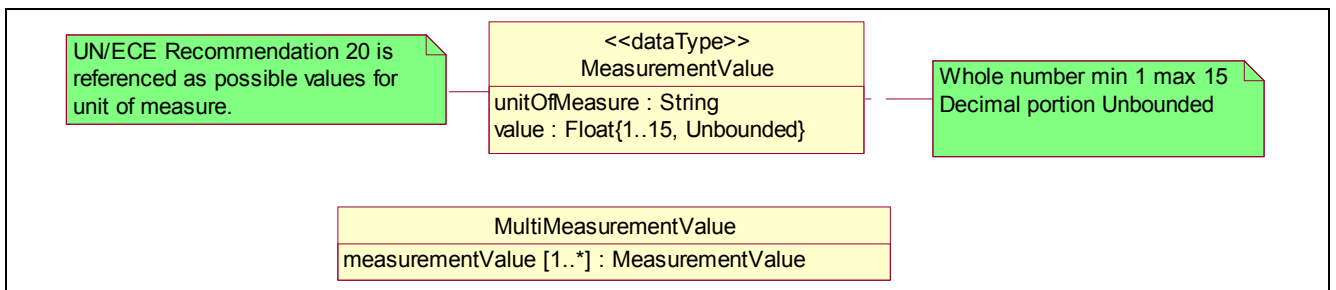

3.3 Package Overview: Data Type

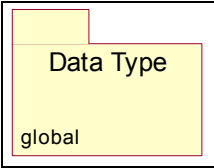

3.3.1 Class Diagram: Data Type

Common Components: Data Type

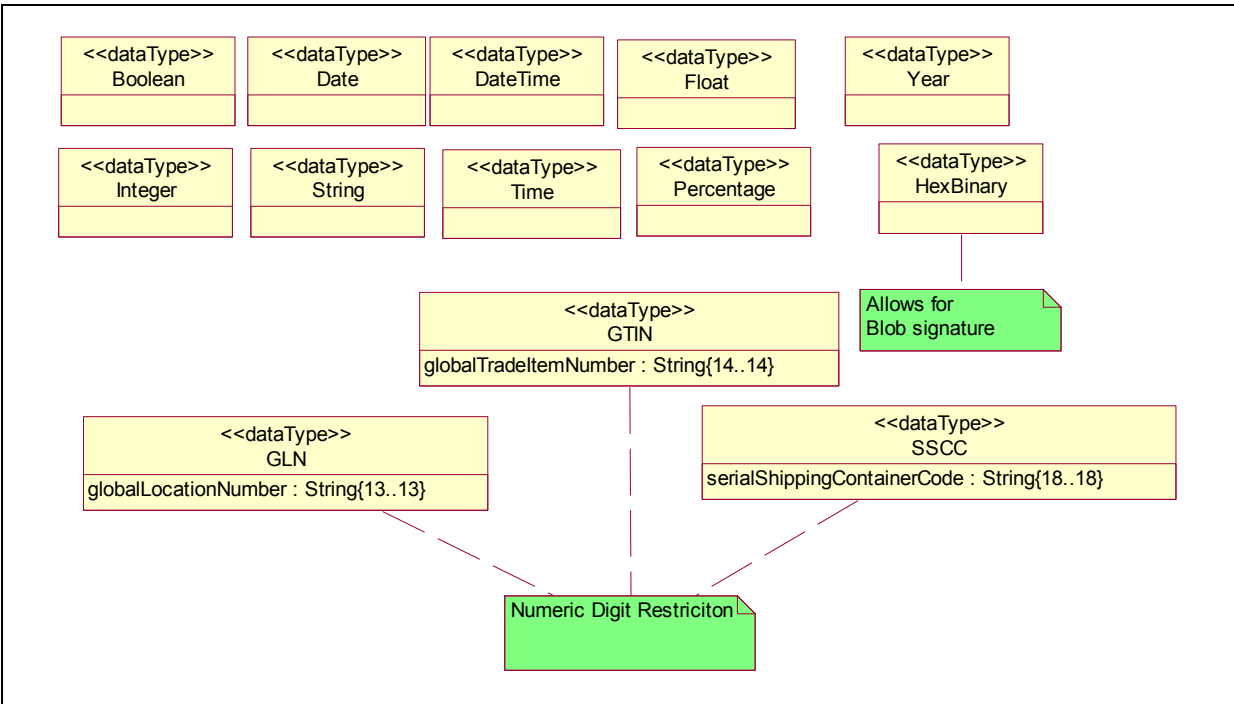

3.4 Package Overview: Extended Data Type

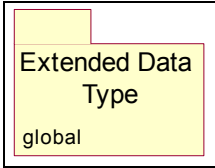

3.4.1 Class Diagram: Extended Data Type

Common Components: Extended Data Type

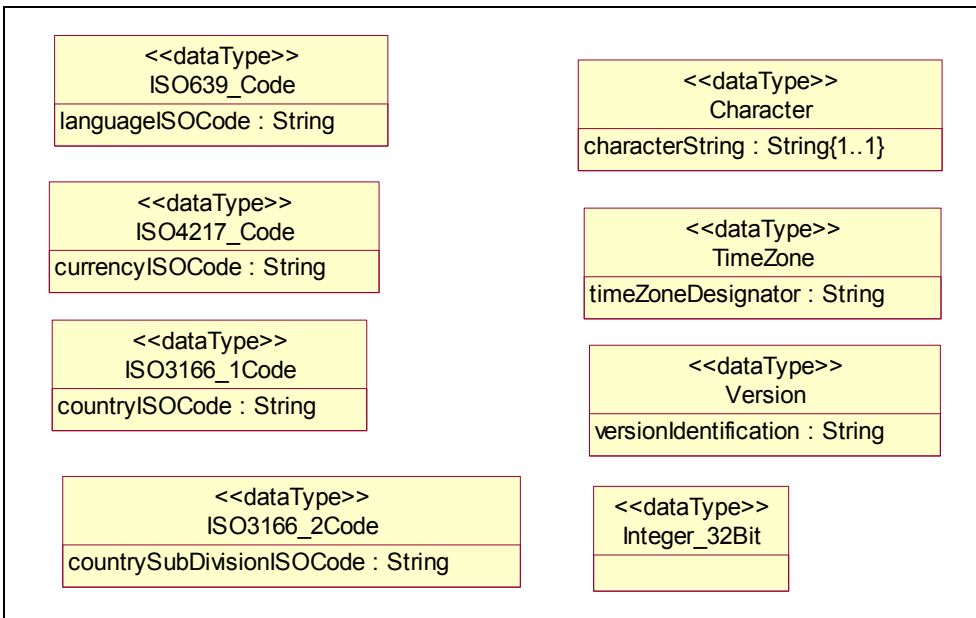

3.5 Package Overview: Identification

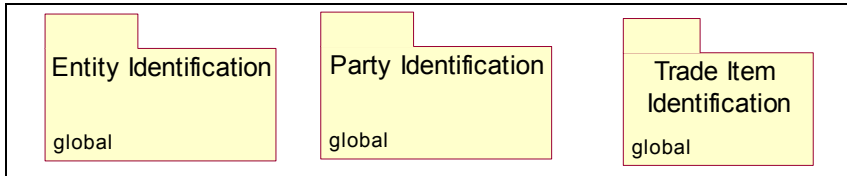

3.5.1 Class Diagram Identification: Entity Identification

Common Components: Identification: Entity Identification

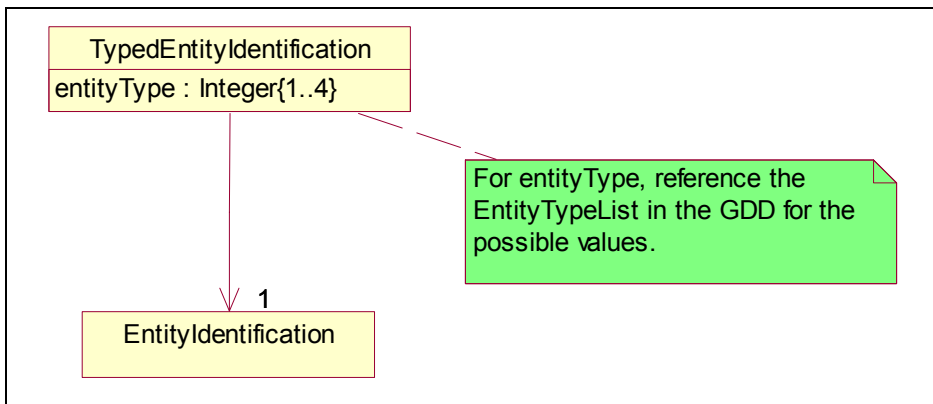
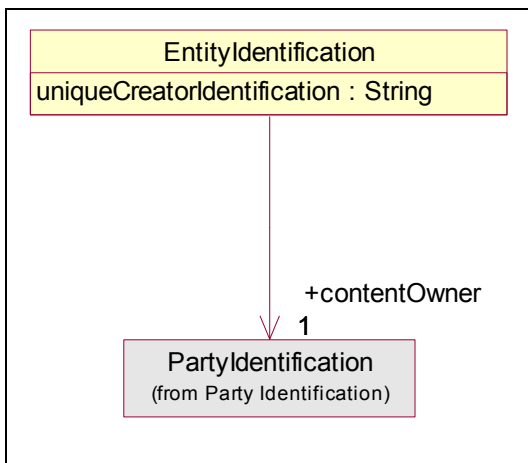

3.5.2 Class Diagram: Identification: Party Identification

Common Components: Identification: Party Identification

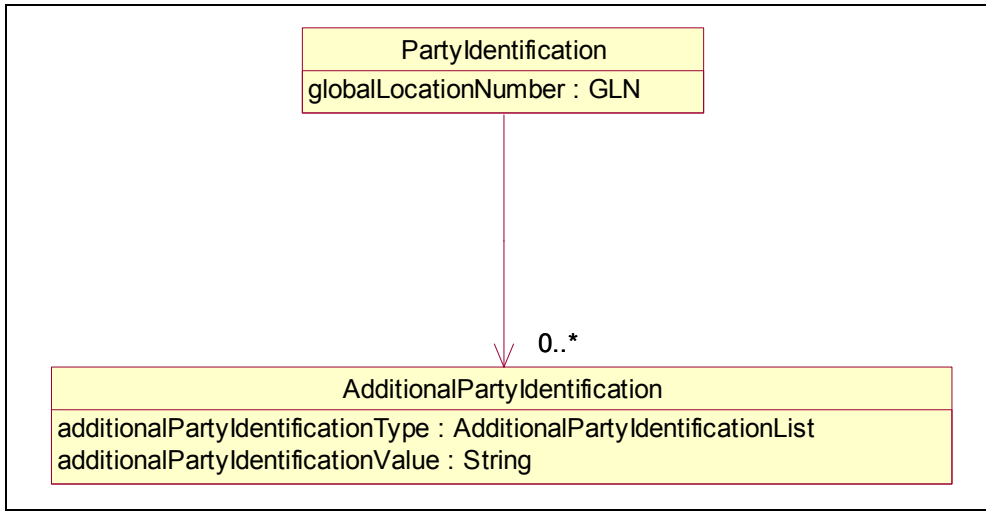

3.5.3 Class Diagram: Identification: Trade Item Identification

Common Components: Identification: Trade Item Identification

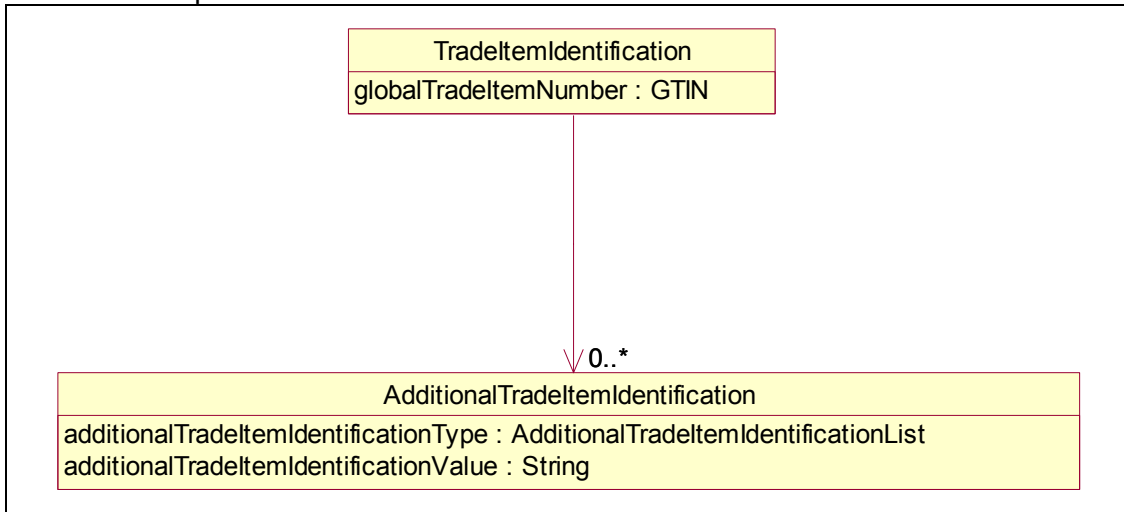

4 Package Overview : Process Common Components

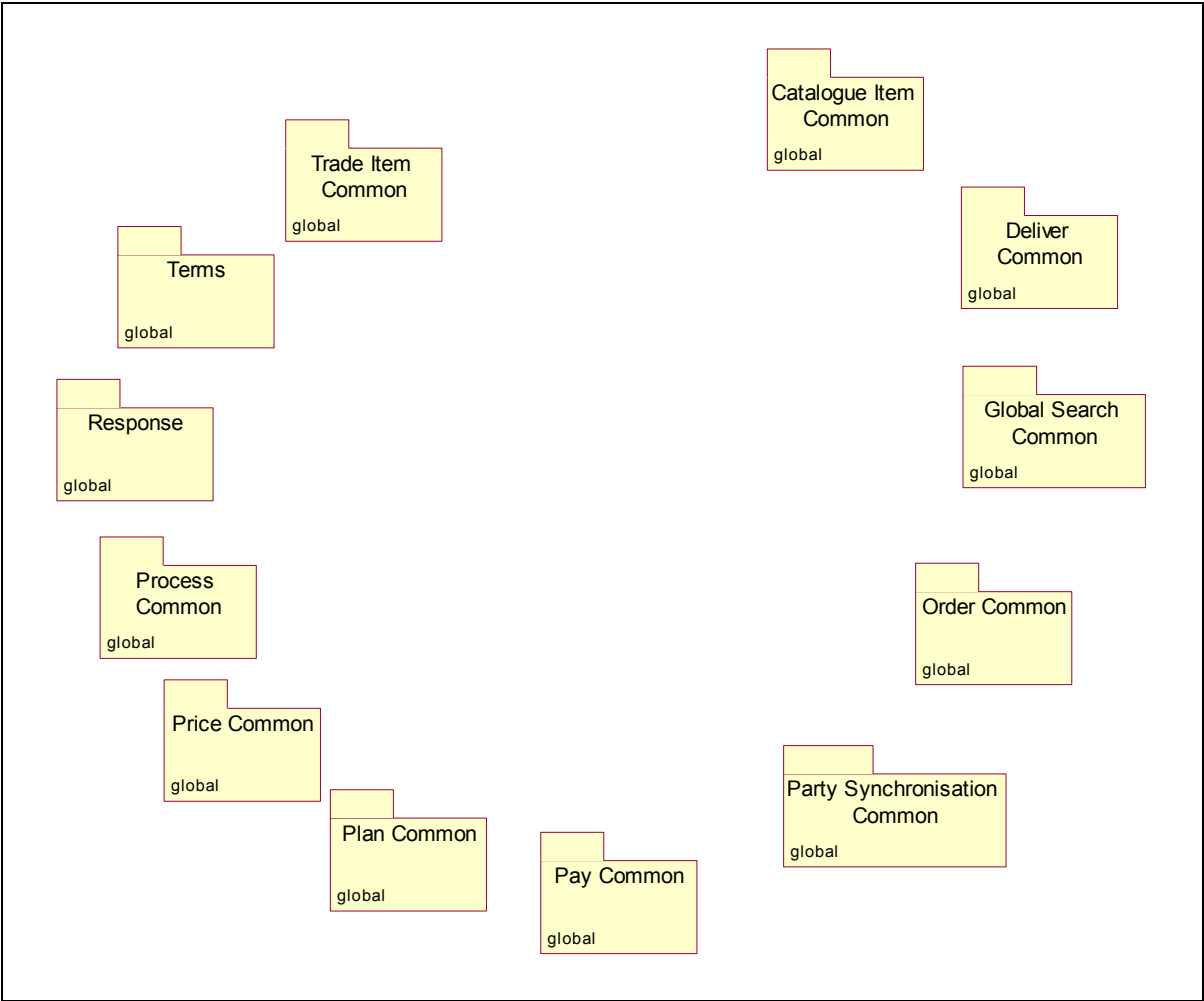

4.1 Package Overview: Catalogue Item Common

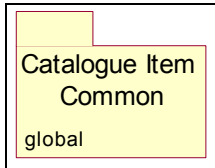

4.1.1 Class Diagram: Catalogue Item Common

Process Common Components: Catalogue Item Common

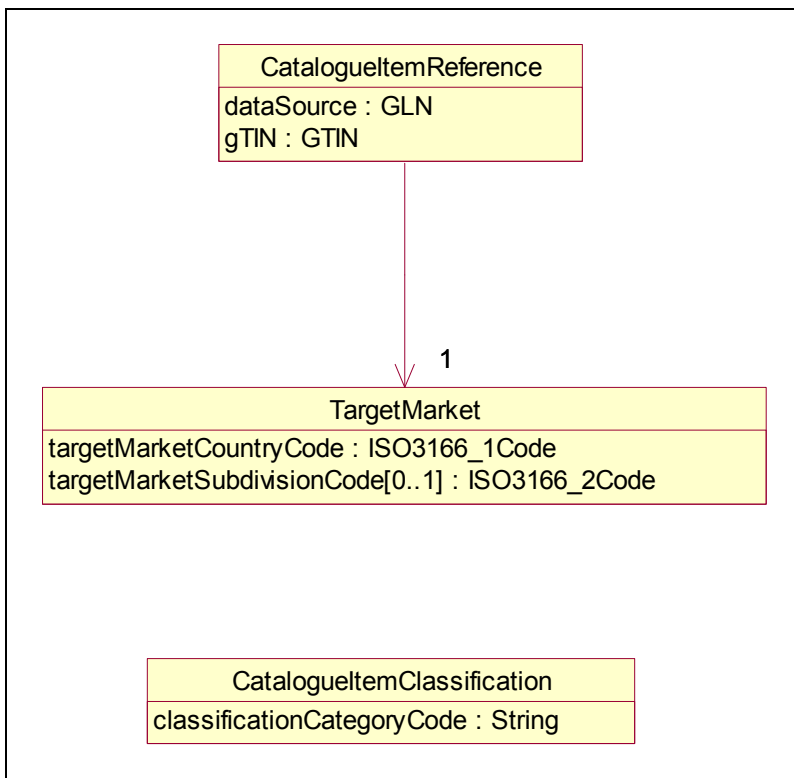

4.2 Package Overview: Deliver Common

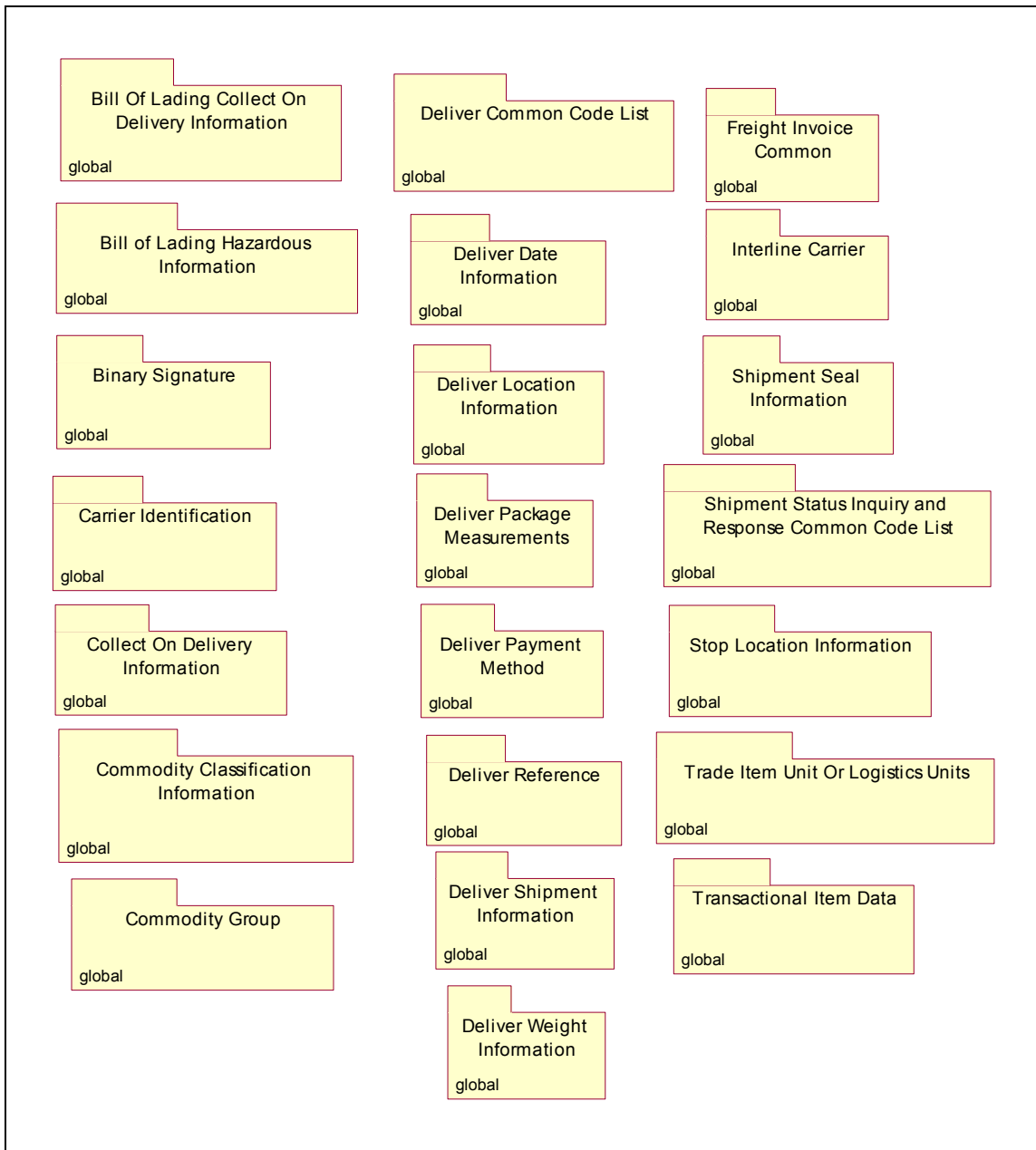

4.2.1 Class Diagram: Bill of Lading Collect On Delivery Information

Process Common Components: Deliver Common: Bill Of Lading Collect On Delivery Information

Business Solution Design

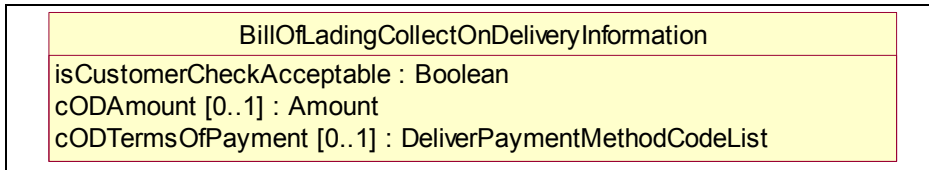

4.2.2 Class Diagram: Bill of Lading Hazardous Information

Process Common Components: Deliver Common: Bill of Lading Hazardous Information

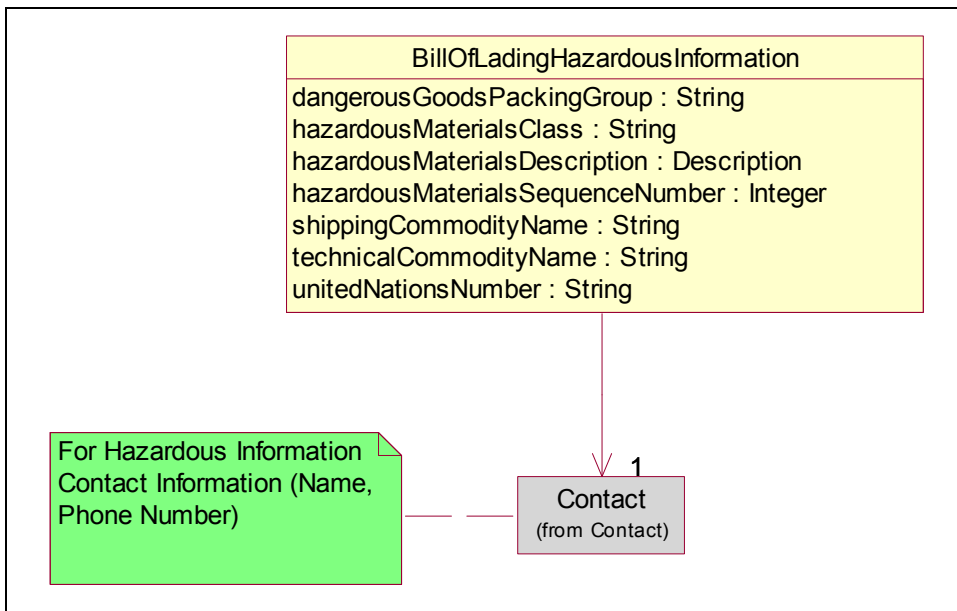

4.2.3 Class Diagram: Binary Signature

Process Common Components: Deliver Common: Binary Signature Information

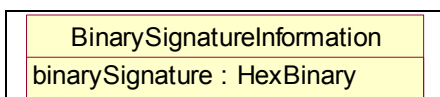

4.2.4 Class Diagram: Carrier Identification

Process Common Components: Deliver Common: Carrier Identification

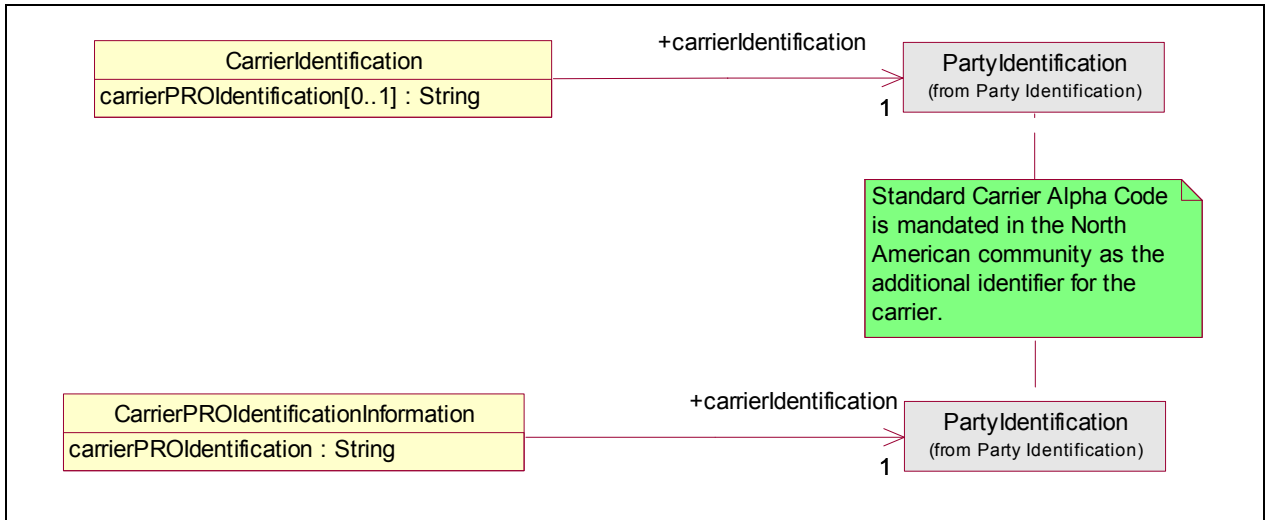

4.2.5 Class Diagram: Collect on Delivery Information

Process Common Components: Deliver Common: Collect on Delivery Information

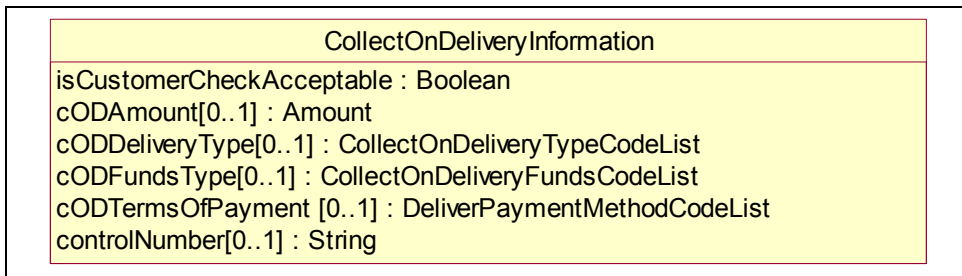

4.2.6 Class Diagram: Commodity Classification Information

Process Common Components: Deliver Common: Commodity Classification Information

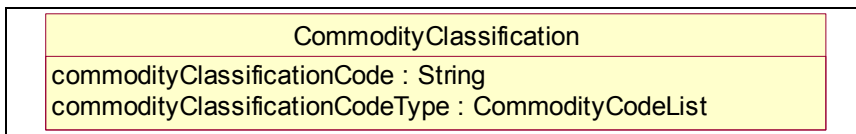

4.2.7 Class Diagram: Commodity Group

Process Common Components: Deliver Common: Commodity Group

Business Solution Design

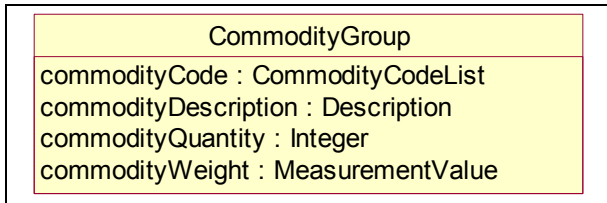

4.2.8 Class Diagram: Deliver Date Information

Process Common Components: Deliver Common: Deliver Date Information

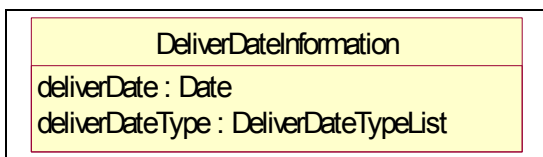

4.2.9 Class Diagram: Deliver Location Information

Process Common Components: Deliver Common: Deliver Location Information

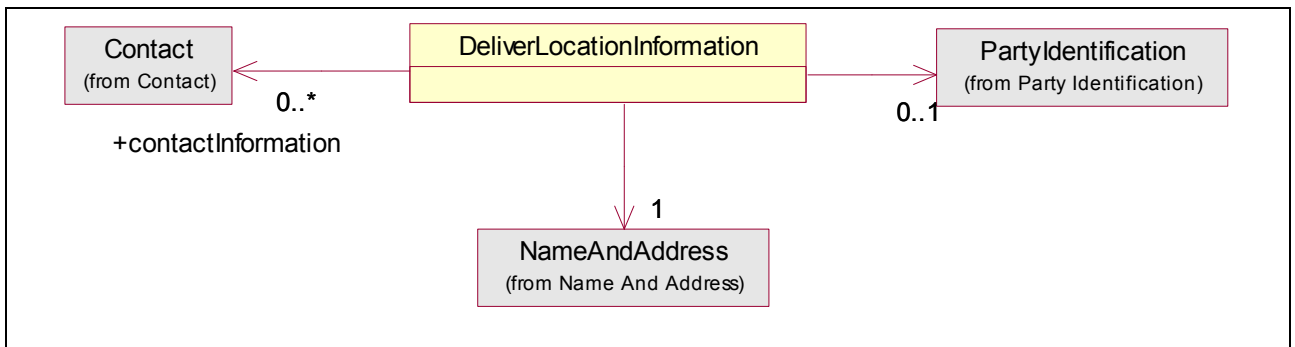

4.2.10 Class Diagram: Deliver Package Measurements

Process Common Components: Deliver Common: Deliver Package Measurements

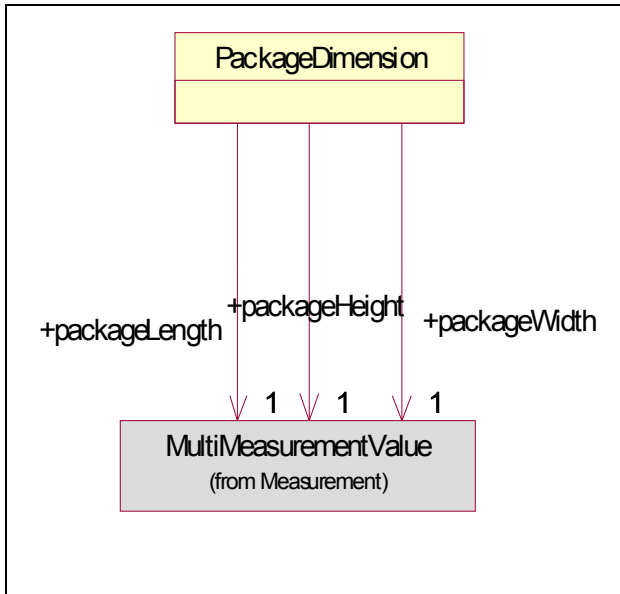

4.2.11 Class Diagram: Deliver Payment Method

Process Common Components : Deliver Common : Deliver Payment Method

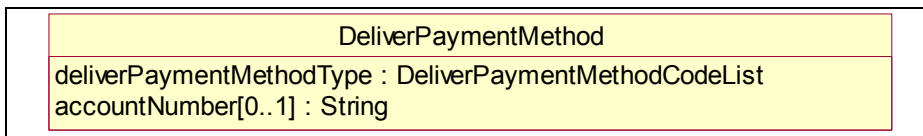

4.2.12 Class Diagram: Deliver Reference

Process Common Components: Deliver Common : Deliver Reference

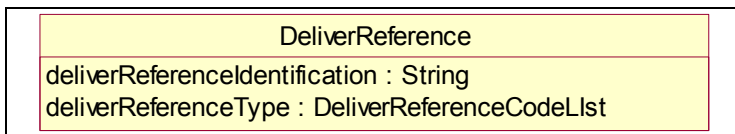

4.2.13 Class Diagram: Deliver Shipment Information

Process Common Components: Deliver Common : Deliver Shipment Information

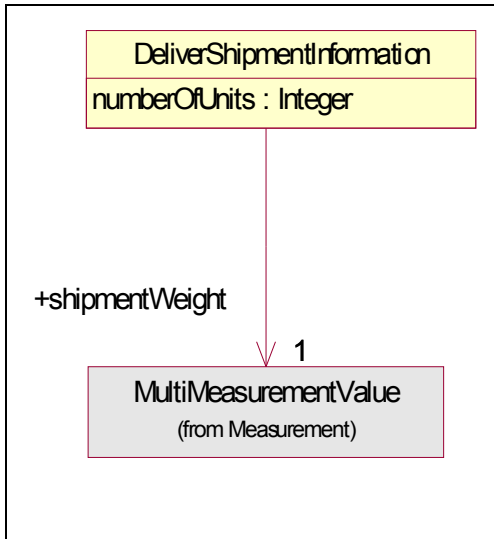

4.2.14 Class Diagram: Deliver Weight Information

Process Common Components: Deliver Common: Deliver Weight Information

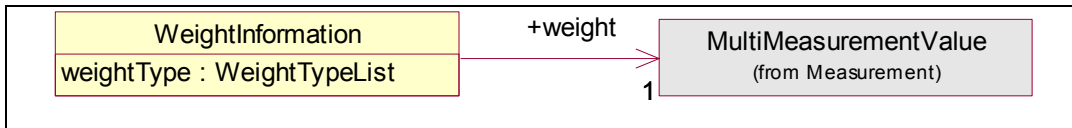

4.2.15 Class Diagram: Freight Invoice Common

Process Common Components: Deliver Common: Freight Invoice Common

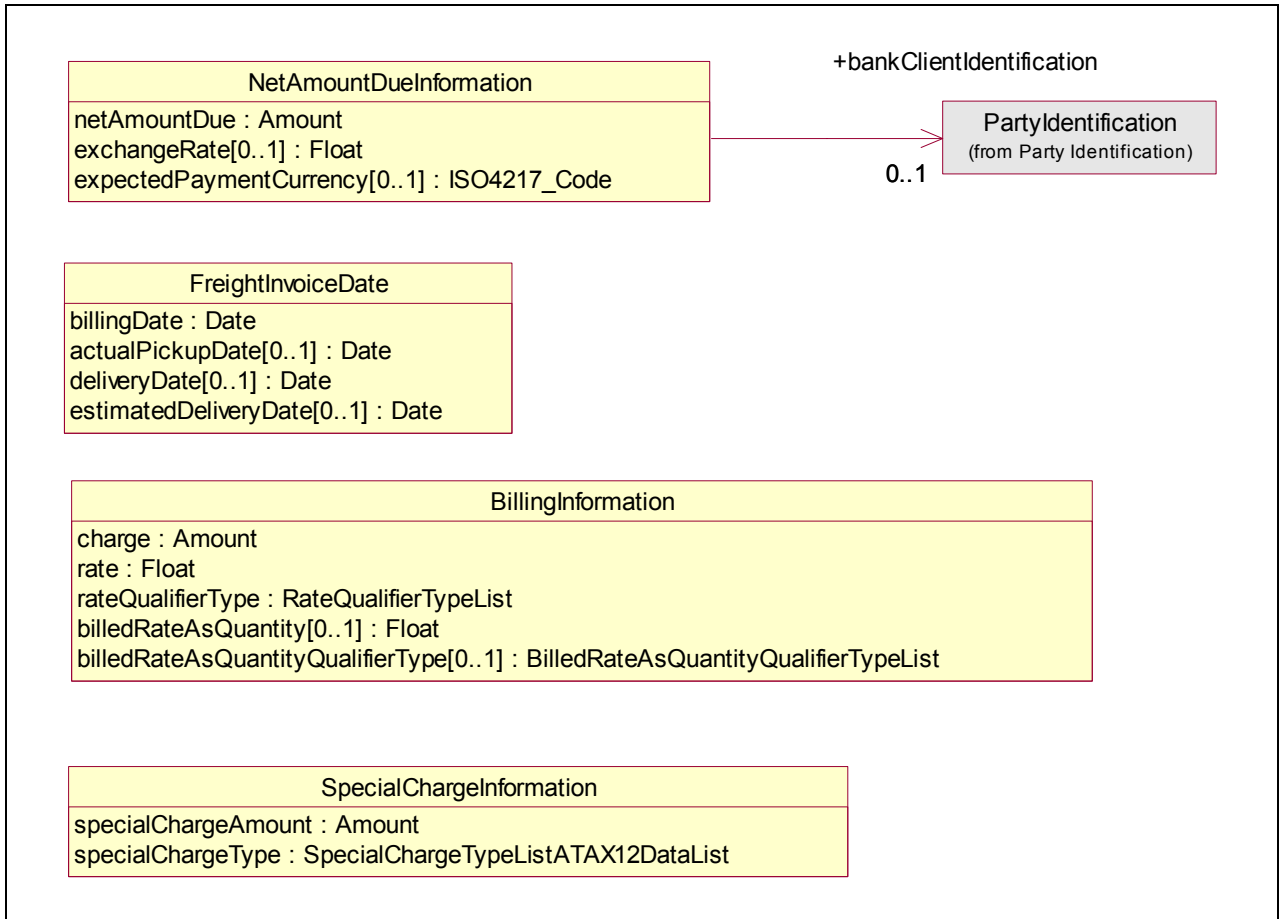

4.2.16 Class Diagram: Interline Carrier

Process Common Components: Deliver Common: Interline Carrier

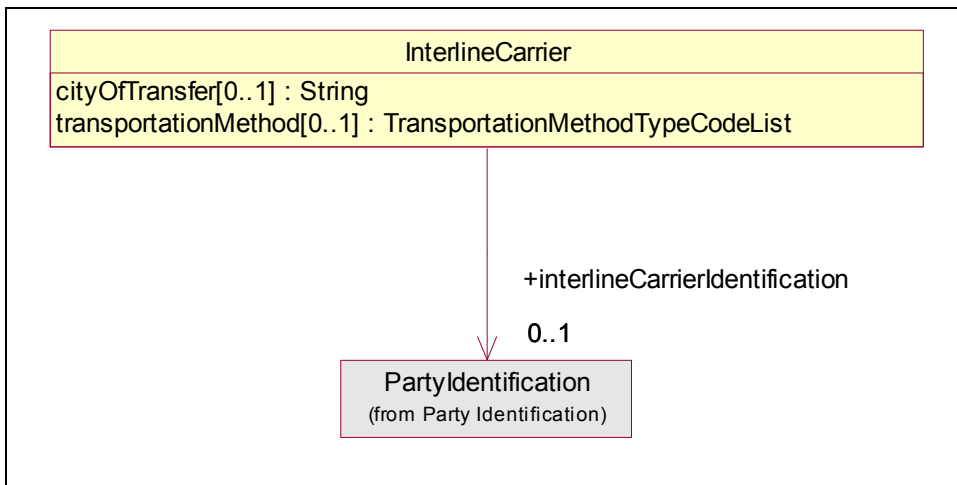

4.2.17 Class Diagram: Shipment Seal Information

Process Common Components: Deliver Common: Shipment Seal Information

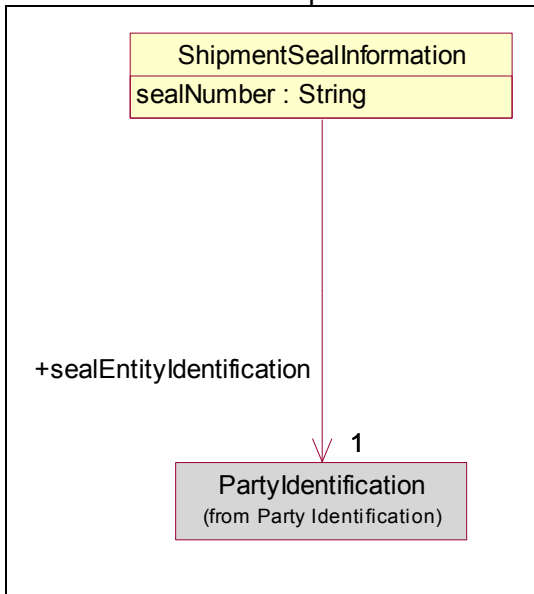

4.2.18 Class Diagram: Stop Location Information

Process Common Components: Deliver Common : Stop Location Information

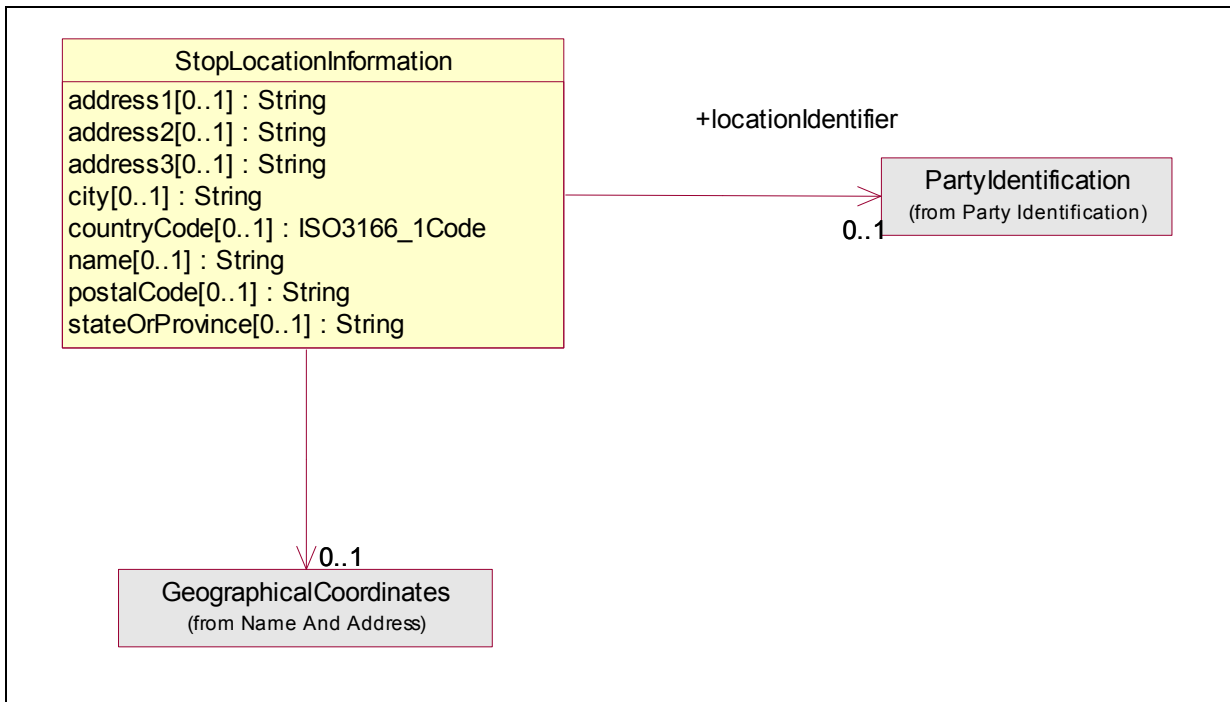

4.2.19 Class Diagram: Trade Item Unit Or Logistics Units

Process Common Components: Deliver Common: Trade Item Unit Or Logistics Units

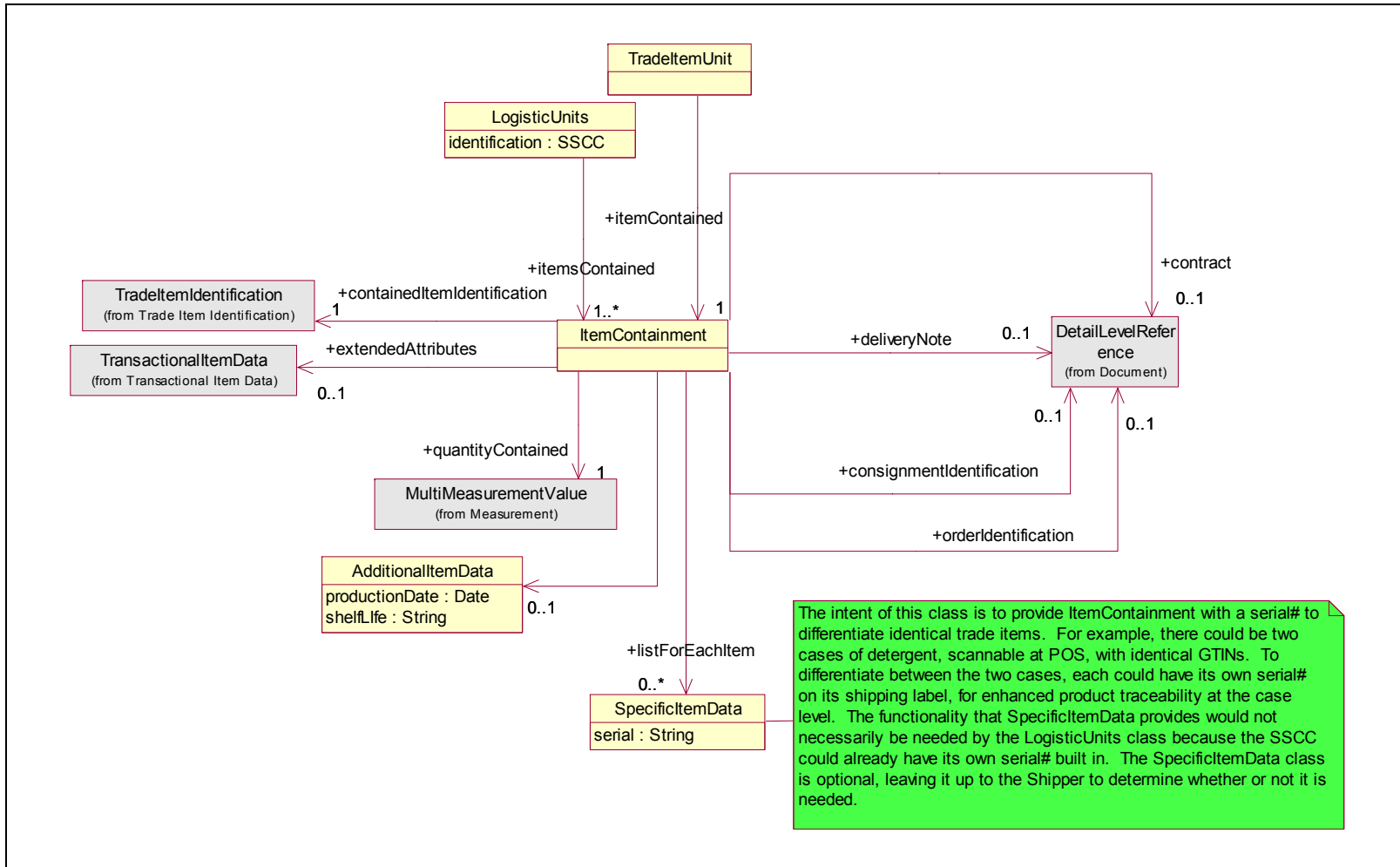

4.2.20 Class Diagram: Transactional Item Data

Process Common Components: Deliver Common: Transactional Item Data

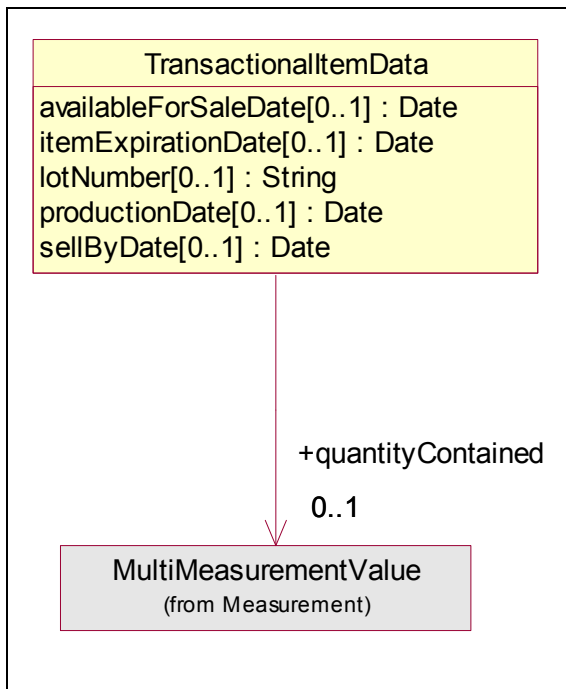

4.3 Package Overview: Global Search Common

Process Common Components: Global Search Common

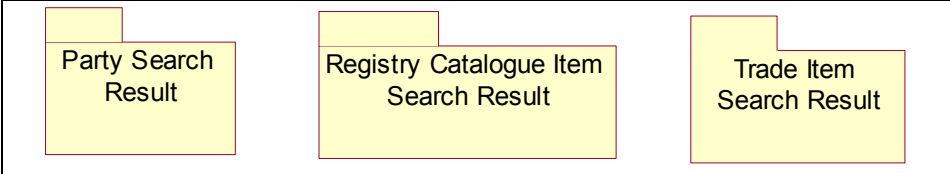

4.3.1 Class Diagram: Party Search Result

Process Common Components: Global Search Common: Party Search Result

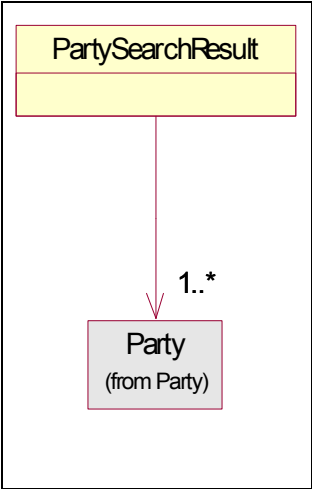

4.3.2 Class Diagram: Registry Catalogue Item Search Result

Process Common Components: Global Search Common: Registry Catalogue Item Search Result

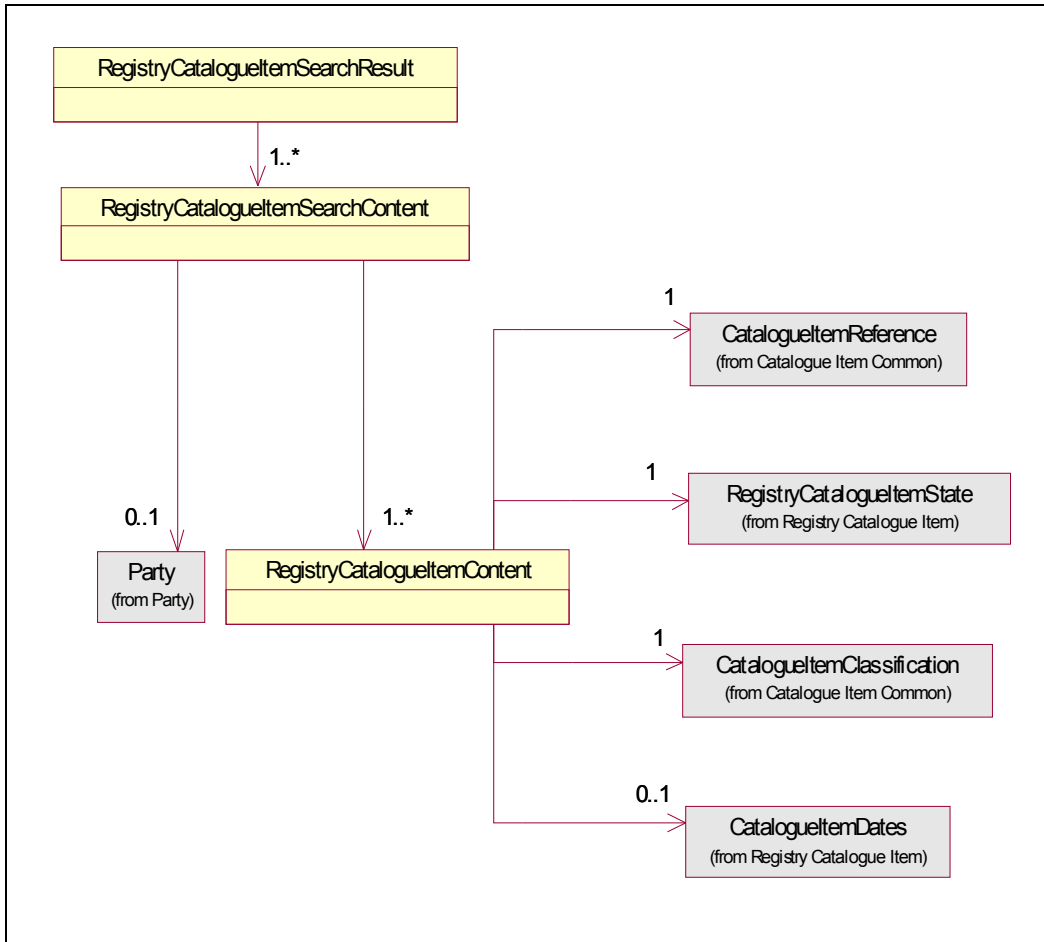

4.3.3 Class Diagram: Trade Item Search Result

Process Common Components: Global Search Common: Trade Item Search Result

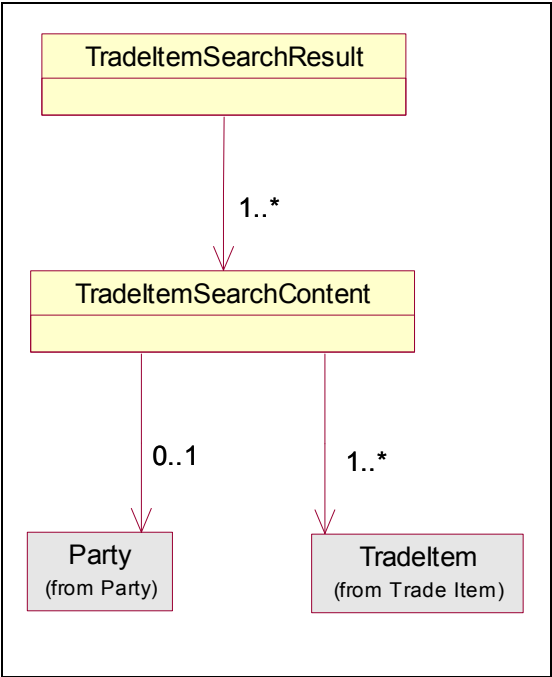

4.4 Package Overview: Order Common

Process Common Components: Order Common: Order Common

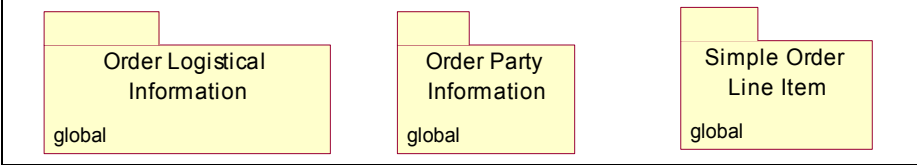

Business Solution Design

4.4.1 Class Diagram: Order Logistical Information

Process Common Components: Order Common: Order Logistical Information

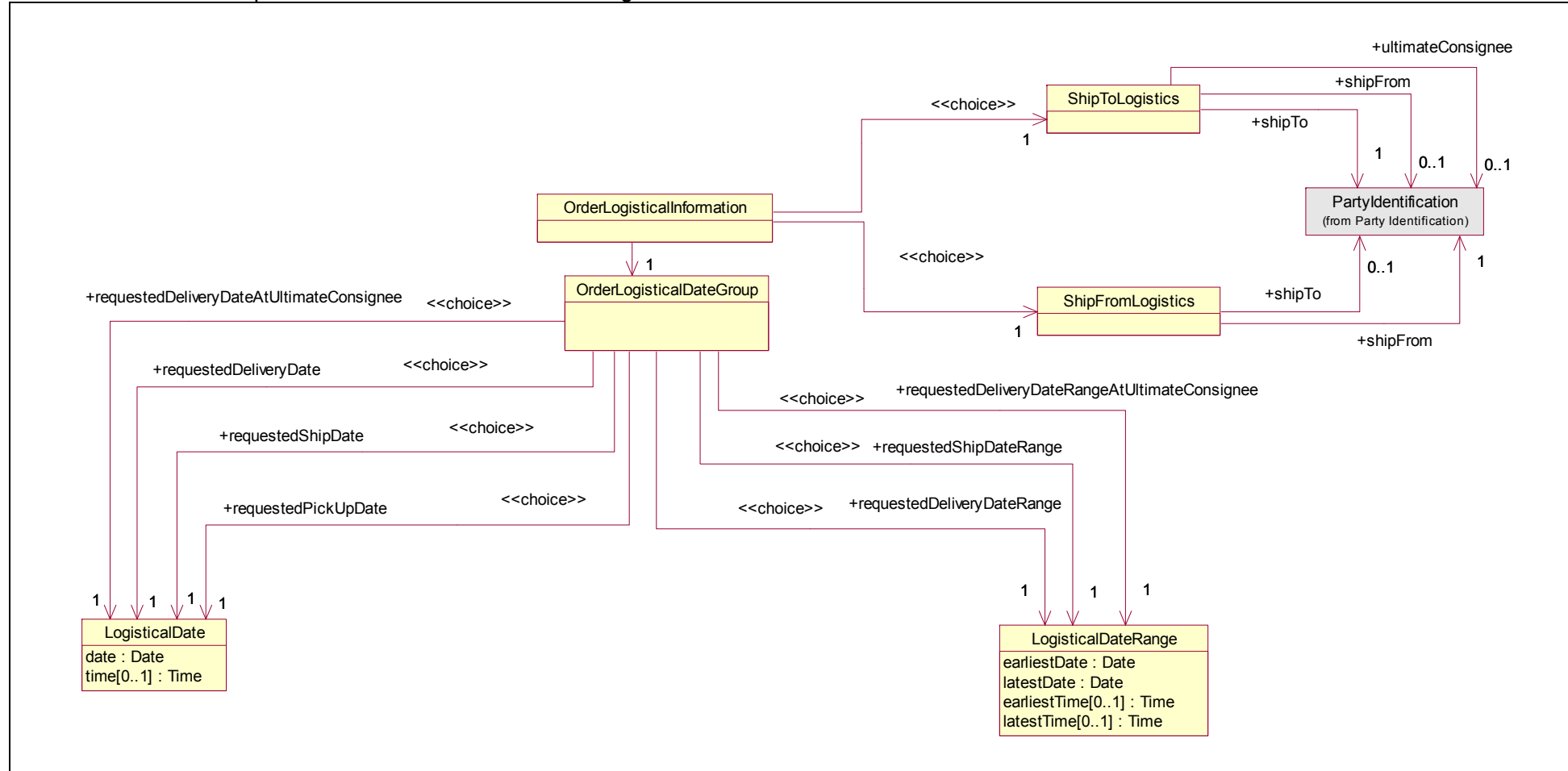

4.4.2 Class Diagram: Order Party Information

Process Common Components: Order Common : Order Party Information

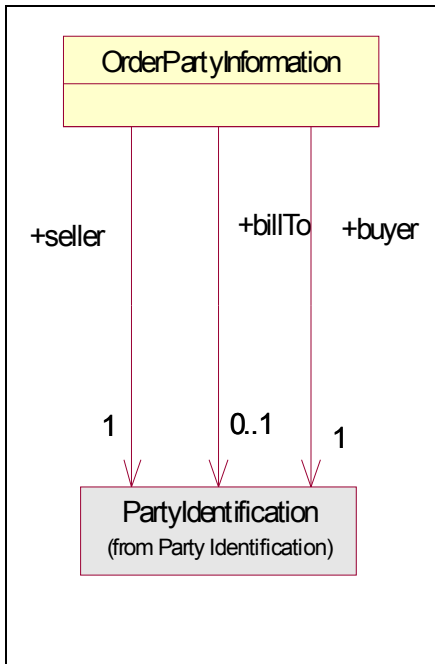

4.4.3 Class Diagram: Simple Order Line Item

Process Common Components: Order Common : Simple Order Line Item

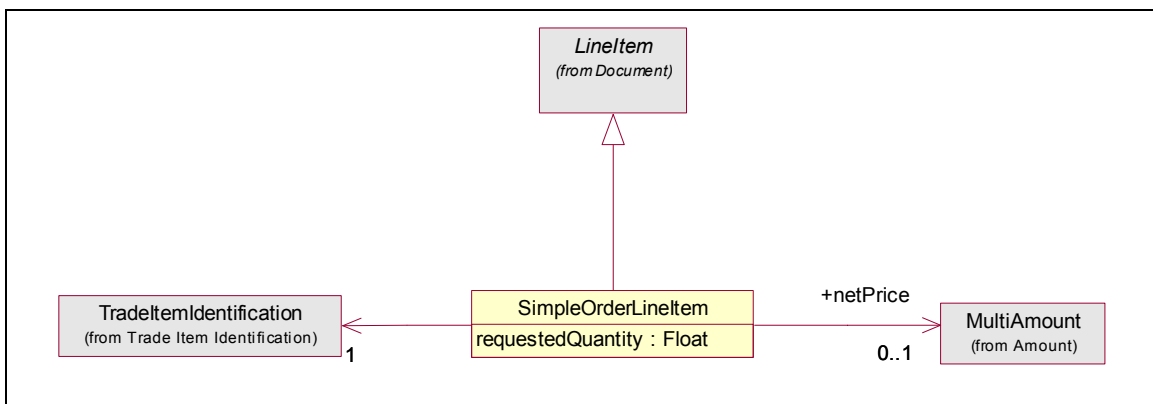

4.5 Package Overview: Party Synchronisation Common

Process Common Components: Order Common: Party Synchronisation Common

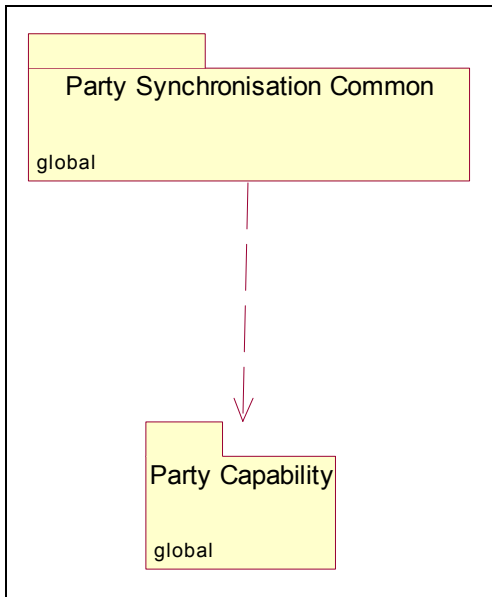

4.5.1 Class Diagram: Party Capability

Process Common Components: Party Synchronisation Common : Party Capability

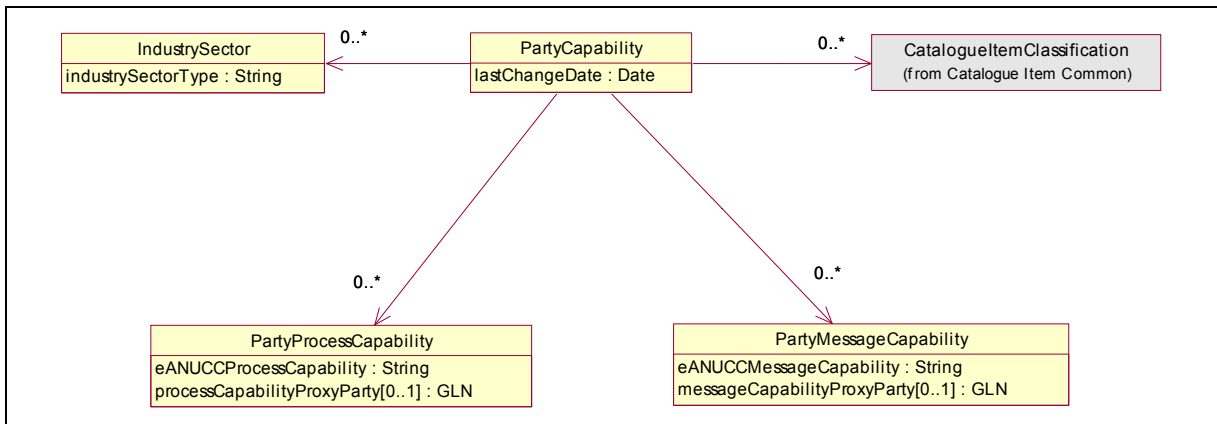

4.6 Package Overview: Pay Common

Process Common Components: Pay Common

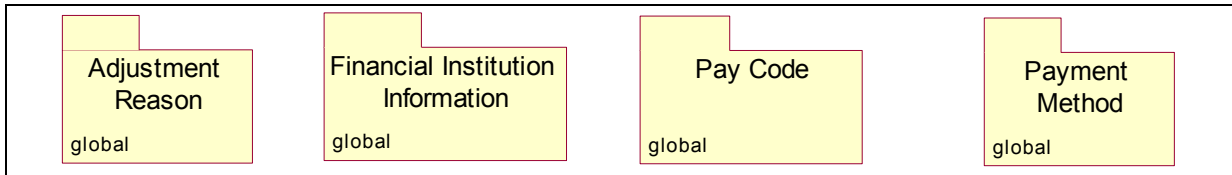

4.6.1 Class Diagram: Adjustment Reason

Process Common Components: Pay Common: Adjustment Reason

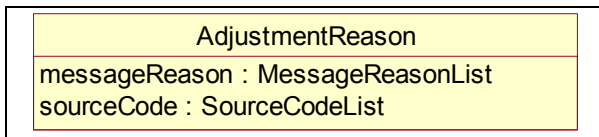

4.6.2 Class Diagram: Financial Institution Information

Process Common Components: Pay Common: Financial Institution Information

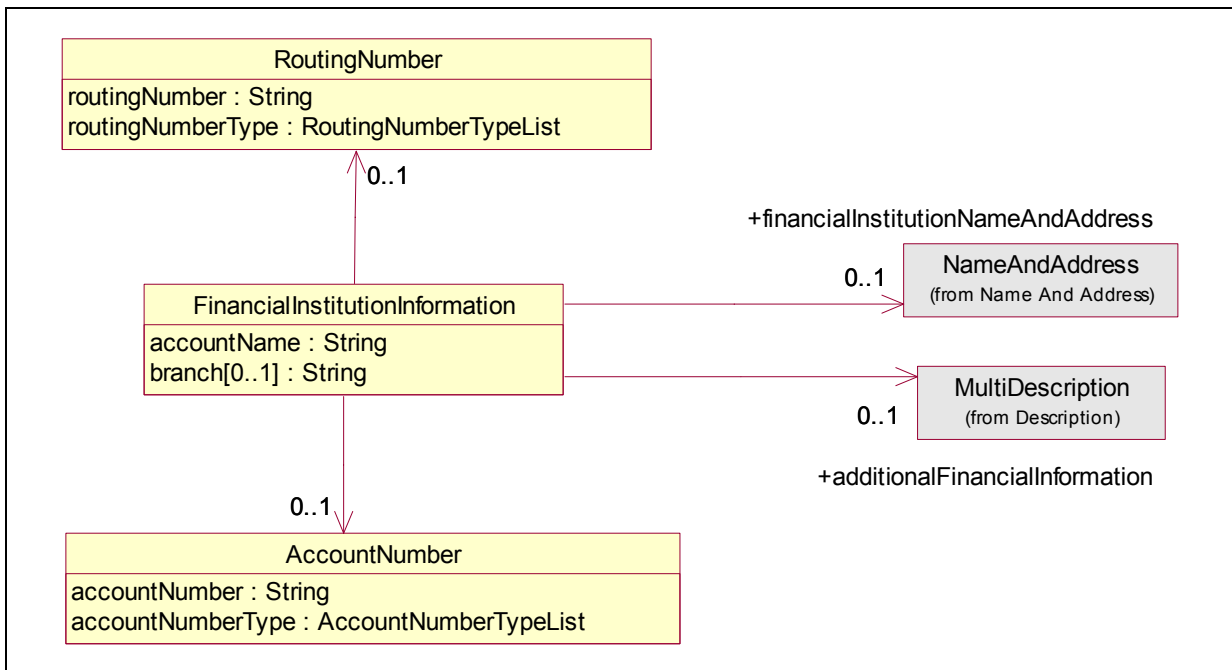

4.6.3 Class Diagram: Pay Code

Process Common Components: Pay Common: Pay Code

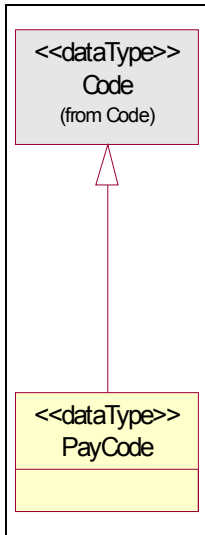

4.6.4 Class Diagram: Payment Method

Process Common Components: Pay Common: Payment Method

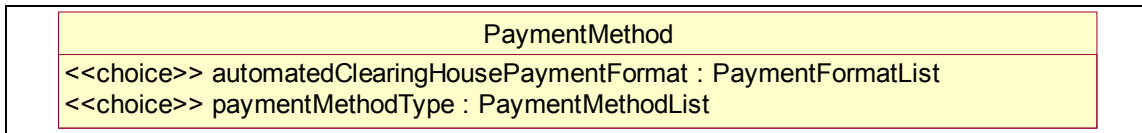

4.7 Package Overview: Plan Common

Process Common Components: Plan Common

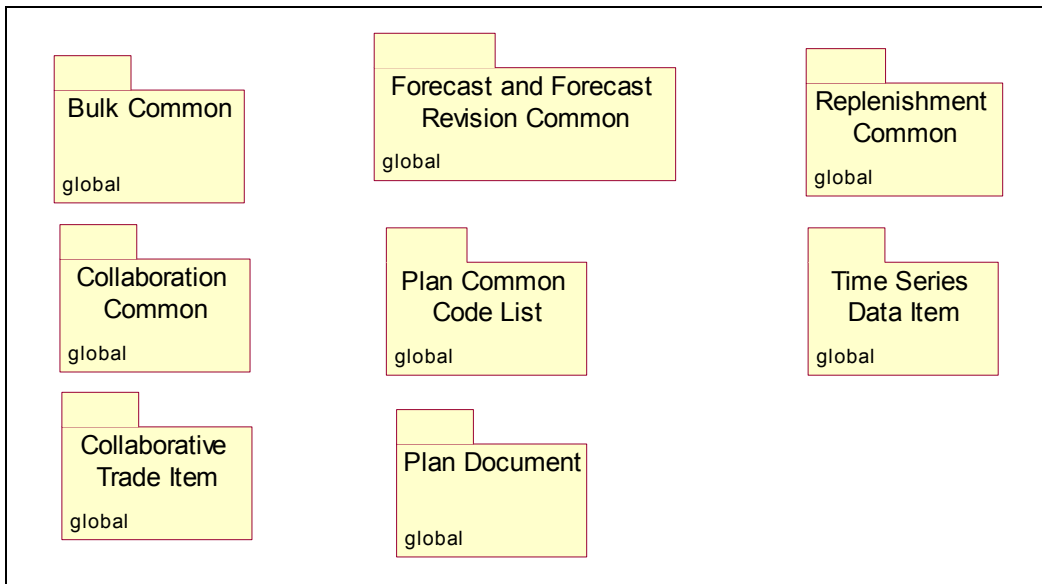

4.7.1 Class Diagram: Bulk Common

Process Common Components: Plan Common: Bulk Common

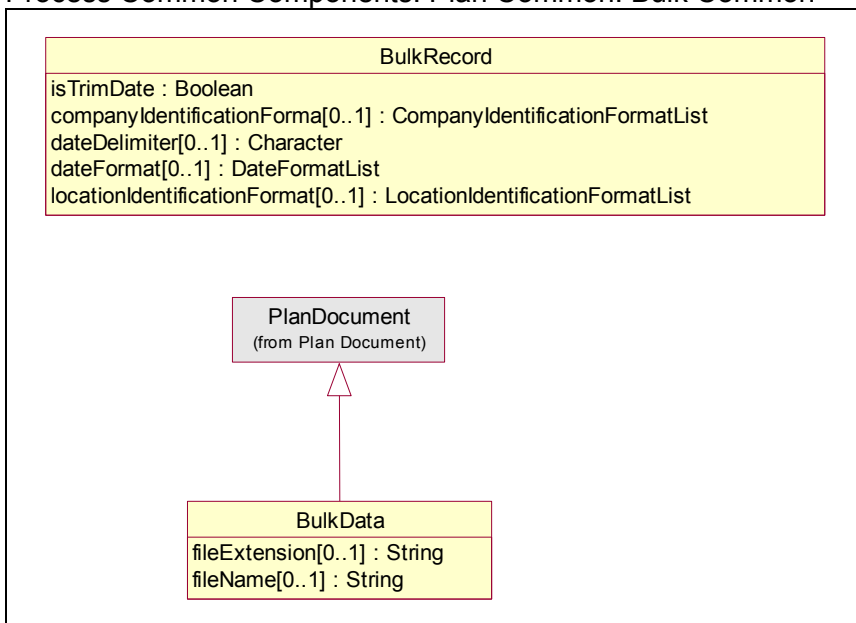

4.7.2 Class Diagram: Collaborative Trade Item

Process Common Components: Plan Common: Collaborative Trade Item

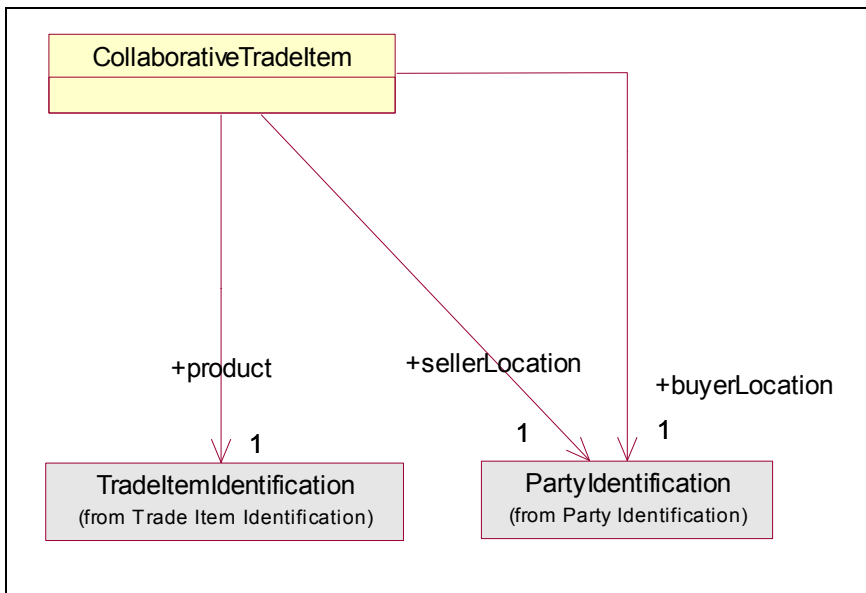

4.7.3 Class Diagram: Forecast and Forecast Revision Common

Process Common Components: Plan Common: Forecast and Forecast Revision Common

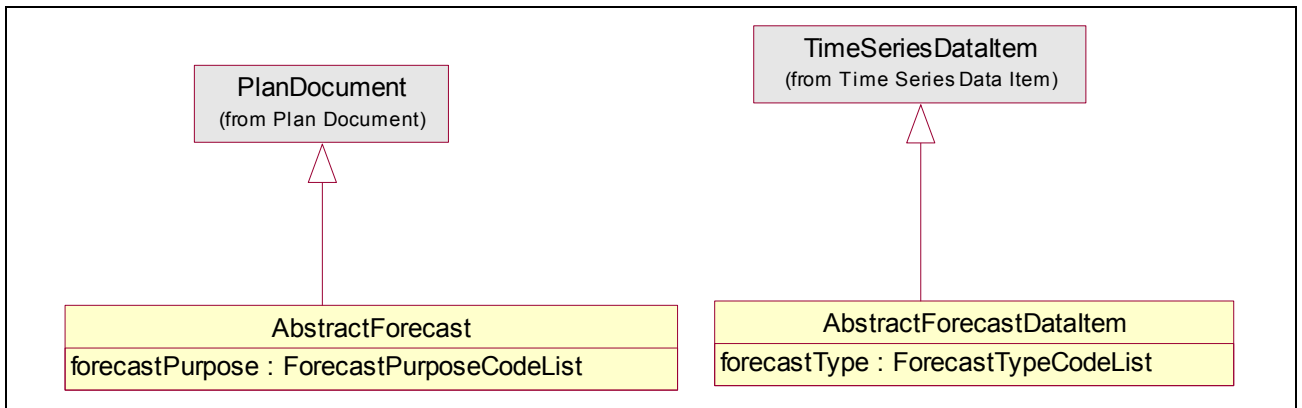

4.7.4 Class Diagram: Plan Document

Process Common Components: Plan Common: Plan Document

Business Solution Design

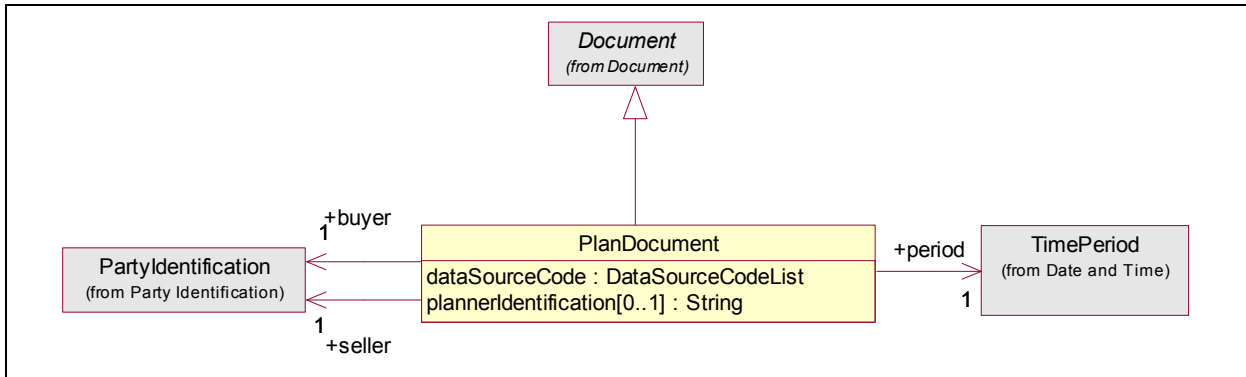

4.7.5 Class Diagram: Replenishment Common

Process Common Components: Plan Common: Replenishment Common

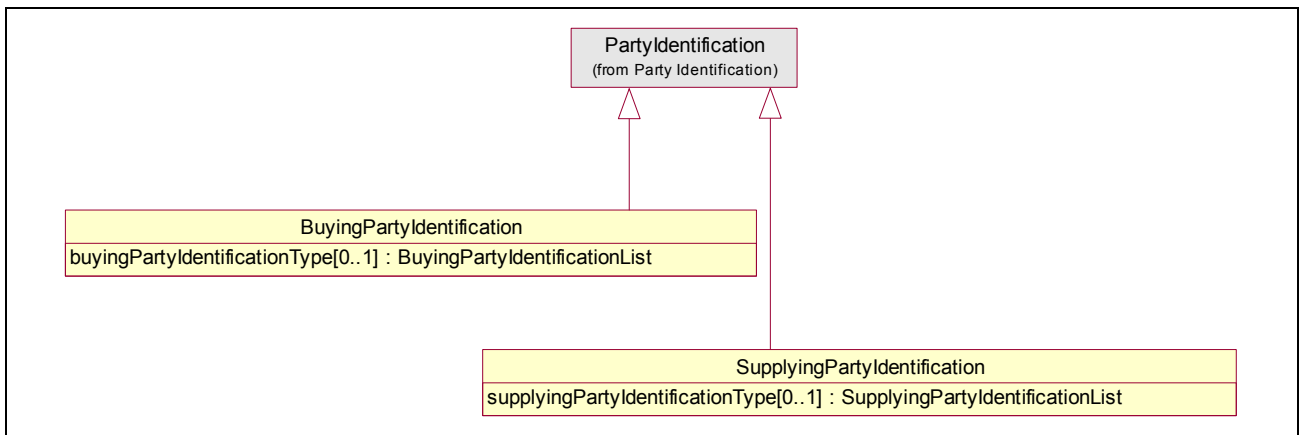

4.7.6 Class Diagram: Time Series Data Item

Process Common Components: Plan Common: Time Series Data Item

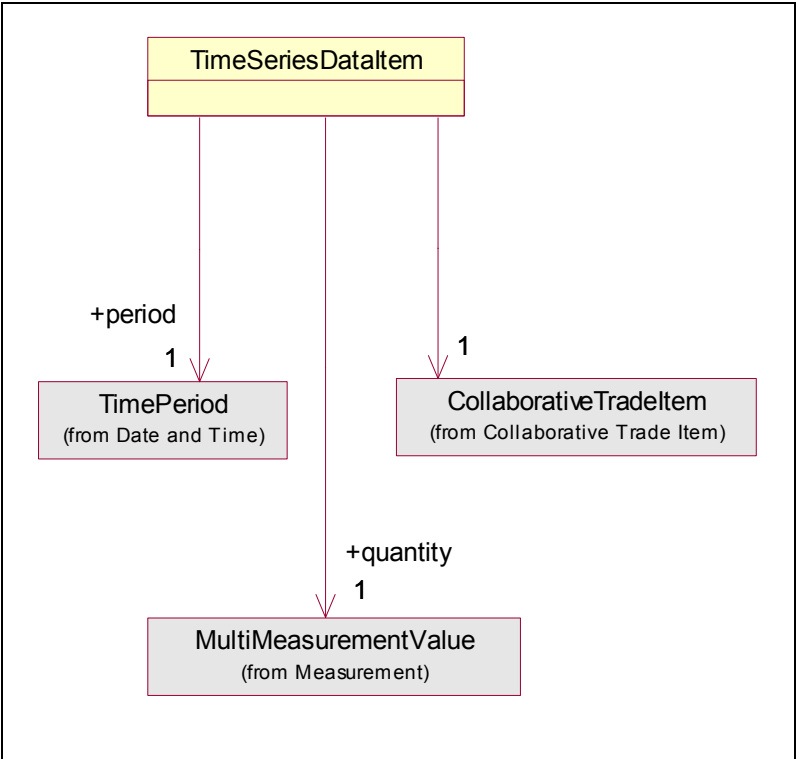

4.8 Package Overview: Price Common

Process Common Components: Price Common

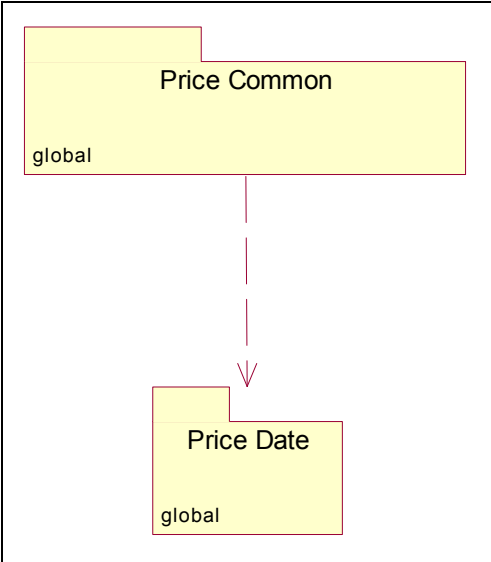

4.8.1 Class Diagram: Price Date

Process Common Components: Price Common : Price Date

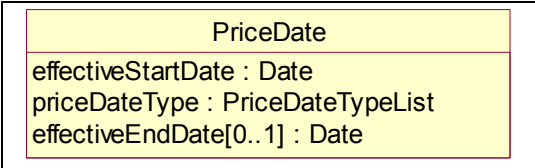

4.9 Package Overview: Process Common

Process Common Components: Process Common

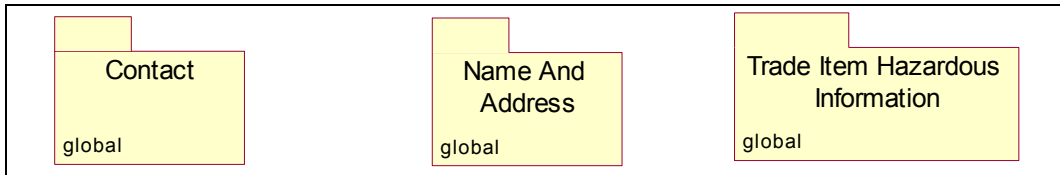

4.9.1 Class Diagram: Contact

Process Common Components: Process Common: Contact

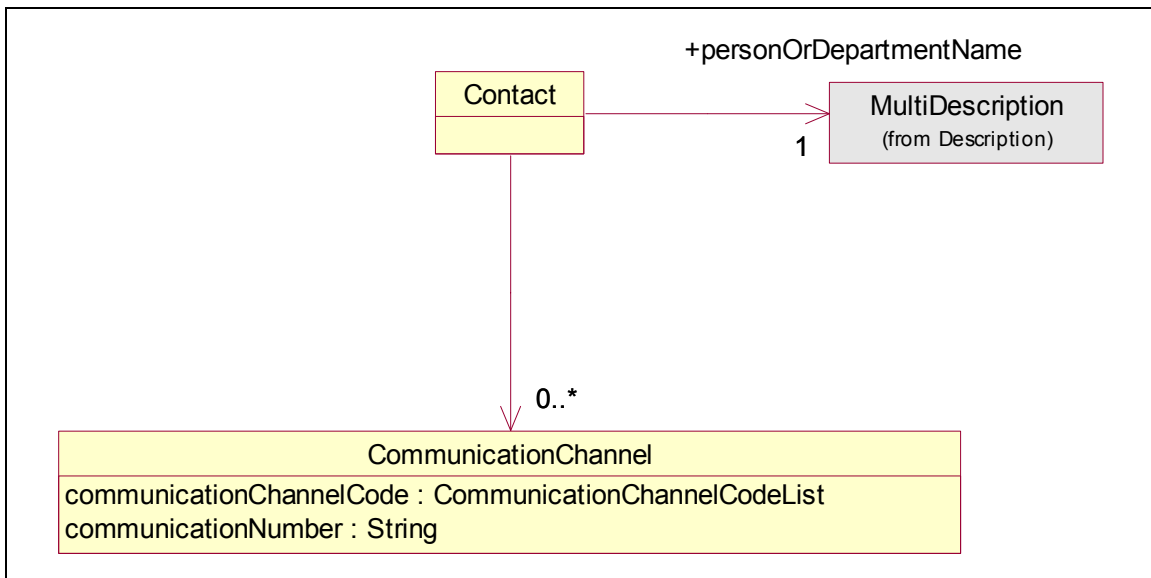

4.9.2 Class Diagram: Name and Address

Process Common Components: Process Common: Name And Address

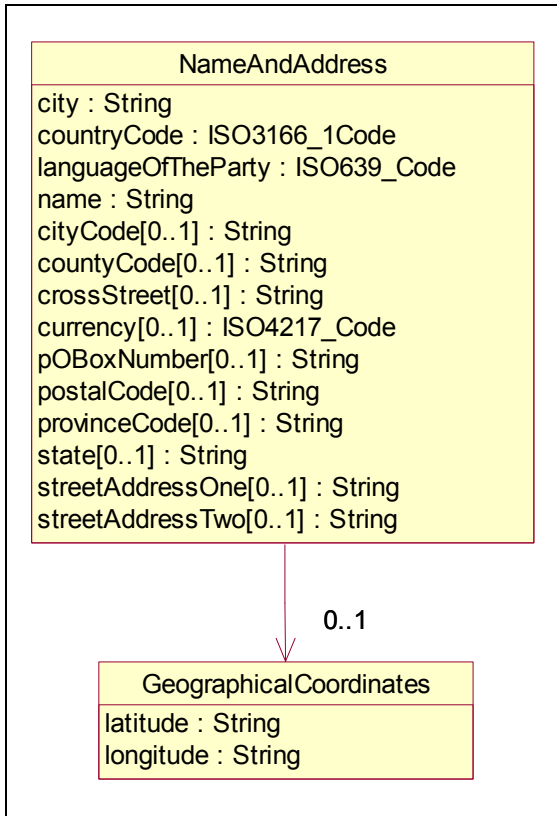

4.9.3 Class Diagram: Trade Item Hazardous Information

Process Common Components: Process Common: Trade Item Hazardous Information

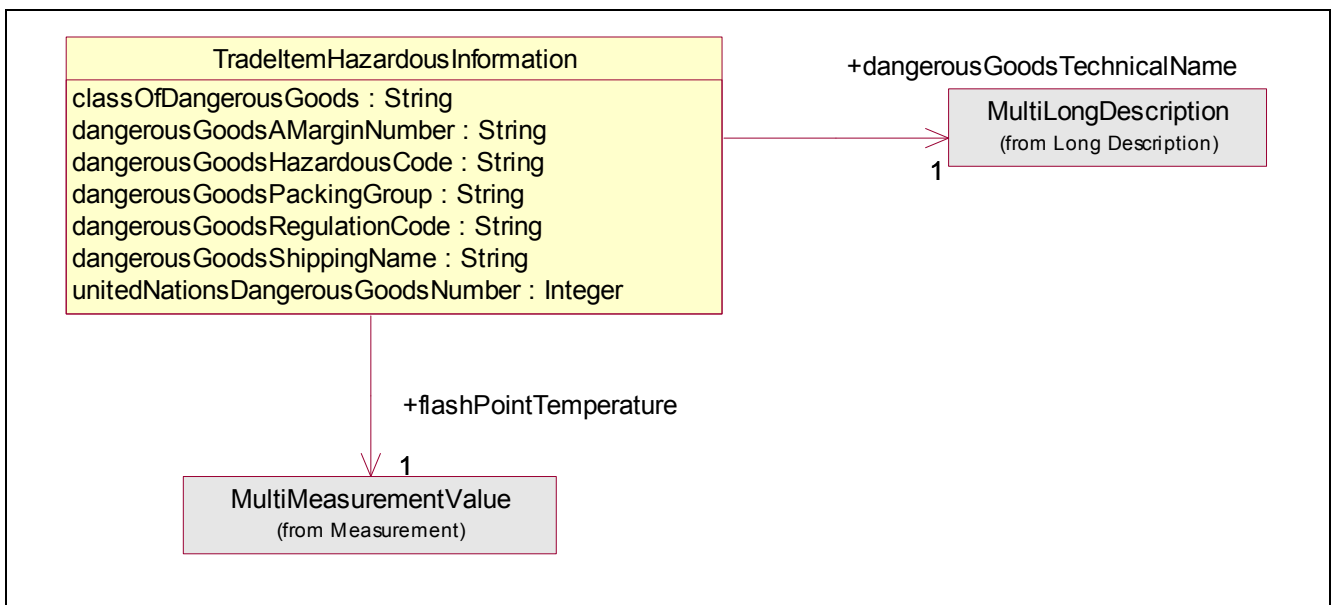

4.10 Package Overview: Price Common

Process Common Components: Response

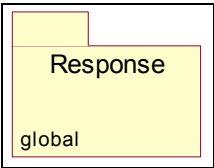

4.10.1 Class Diagram: Response

Process Common Components: Response

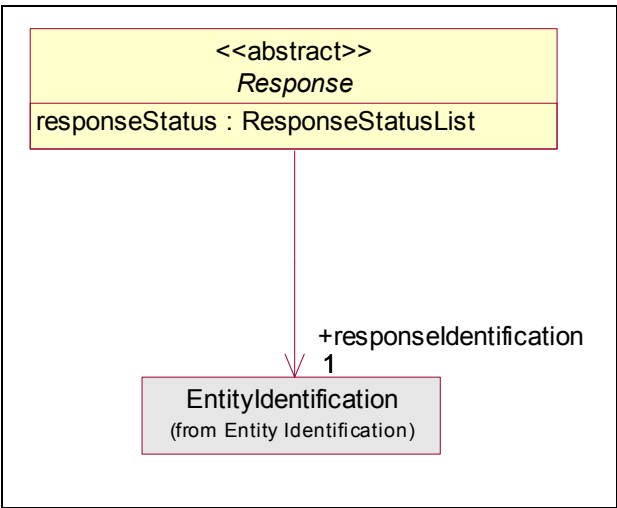

4.11 Package Overview: Terms

Process Common Components: Terms

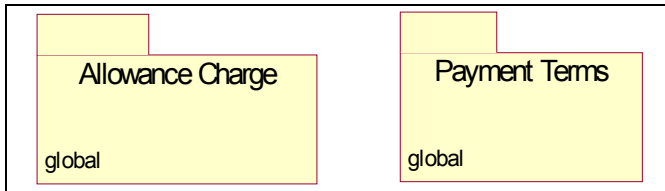

4.11.1 Class Diagram: Allowance Charge

Process Common Components: Terms: Allowance Charge

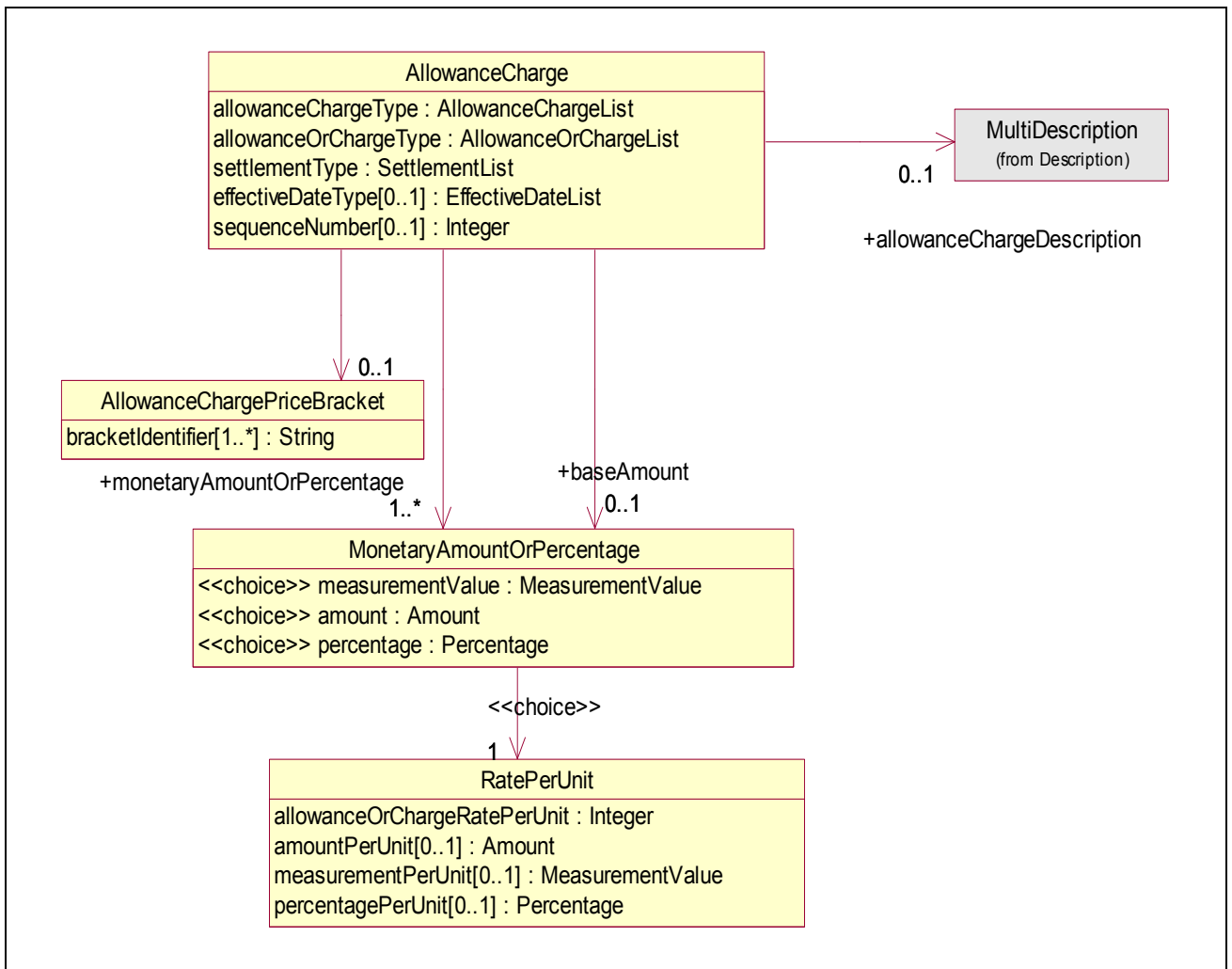

Business Solution Design

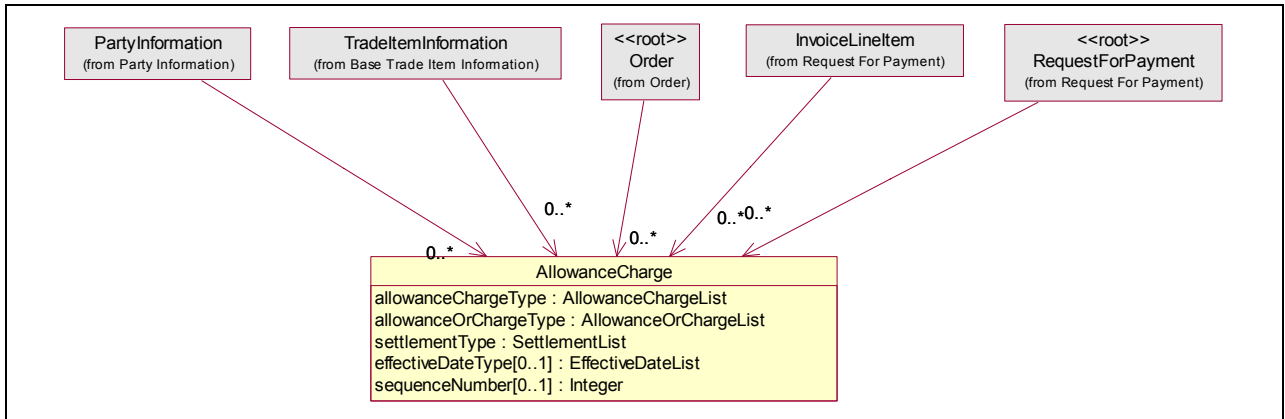

4.11.2 Class Diagram: Payment Terms

Process Common Components: Terms: Payment Terms

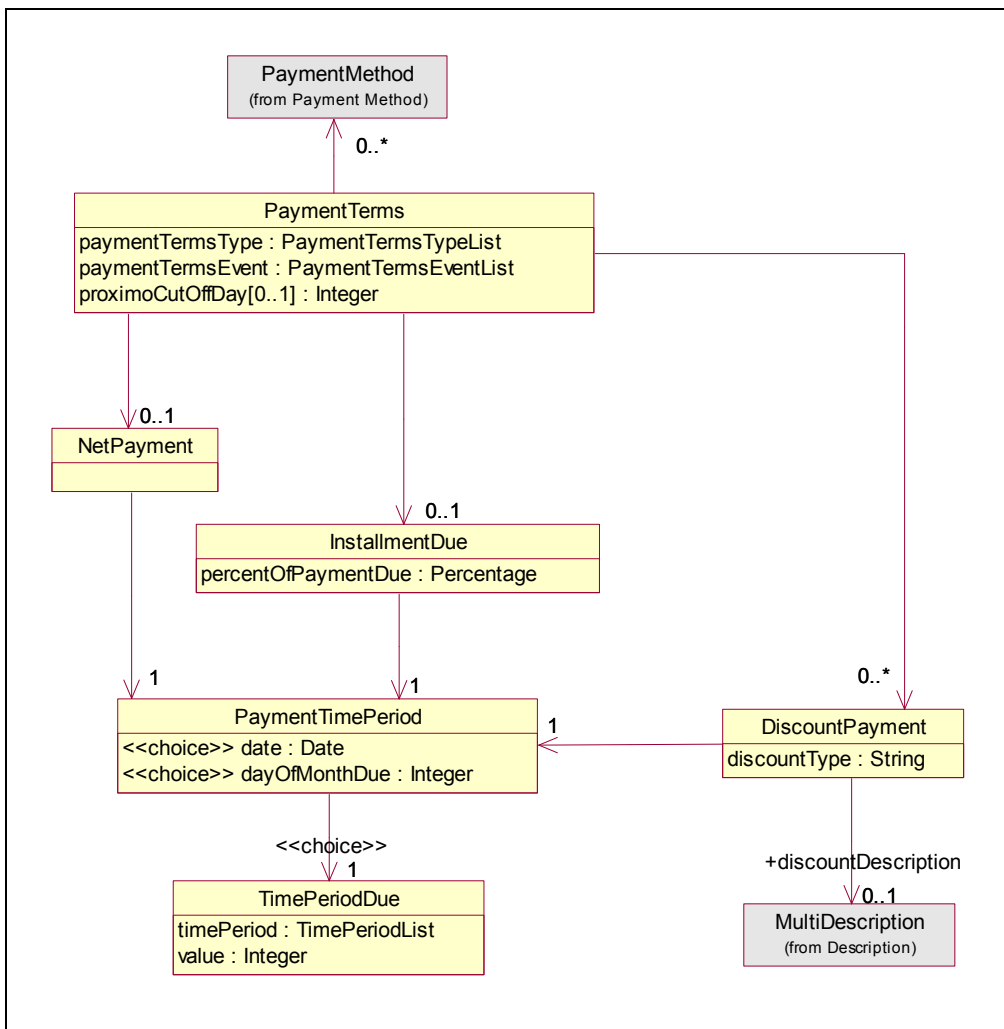

Business Solution Design

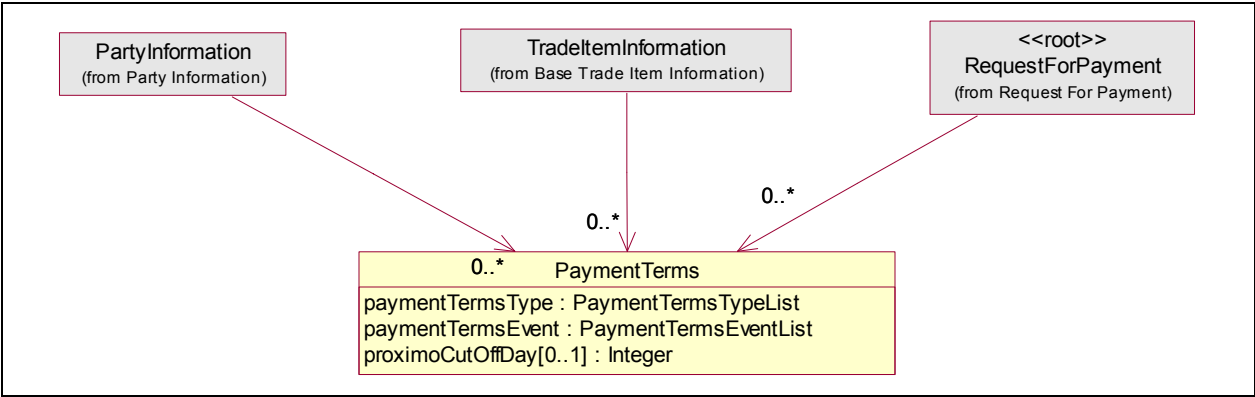

4.12 Package Overview: Trade Item Common



4.12.1 Class Diagram: Trade Item Market Information

Process Common Components: Trade Item Common: Trade Item Market Information

