



Business Message Standard (BMS) Common Library

BMS Release: 2.6.0, BRG Name: eCom

Issue 0.7.3, 30-Oct-2009



Document Summary

Document Item	Current Value
Document Title	Business Message Standard (BMS)
BMS Name	Common Library
BMS Release	2.6.0
BRG Name	eCom
Document Number	Issue 0.7.3
Date Last Modified	30-Oct-2009
Status	Approved
Owner	eCom BRG
BMS Template Version	1.9

Business Requirements Document (BRAD) Reference

BRAD Title:	BRAD Date:	BRAD Version
BRAD eCom Maintenance Release 2 BMS 2.6.0	29-Jun-2009	Version 0.1.1

Document Change History

Date of Change	Version	Changed By	Reason for Change	Summary of Change	Model Build #
07 – Dec – 2004	0.1.1	John Ryu	Maps to the GBM Structure. Ready for 1 st draft XML Development. Excludes Plan	Separated Common Library in chapter 3 (Common Components) and Chapter 4 (Process Common Components)	
09 – Dec- 2004	0.1.2	John Ryu	Updates Finished Plan Common Library	Detail changes are provided in Summary of Changes Plan Common library section added in 4.7	4948
13 – Dec- 2004	0.1.3.	John Ryu	Updated to common library	Detail changes are provided in Summary of Changes	MDL P4CL : 5055
13 – Dec- 2004	0.1.4	John Ryu	Added Code Lists	Added code list into section 1.5.4 Detail changes are provided in Summary of Changes	MDL P4CL : 5094
16 – Dec- 2004	0.1.5	John Ryu	Updated to the Code List	Detail changes are provided in Summary of Changes	
17 – Dec- 2004	0.1.6	John Ryu	Update	Detail changes are provided in Summary of Changes	

Date of Change	Version	Changed By	Reason for Change	Summary of Change	Model Build #
18 – Feb-2005	0.1.7	John Ryu	Updates based on Order 2.0.1 work	Detail changes are provided in Summary of Changes	MDL P4CL :5774 BSD P4CL : 5781
28 – Feb-2005	0.1.8	John Ryu	Updates based on public review Order	Detail changes are provided in Summary of Changes	MDL P4CL : 5805 BSD P4CL : 5806
11 – Mar -2005	0.1.9	John Ryu	Based on 2.0.1 Plan work	Detail changes are provided in Summary of Changes	MDL P4CL : 6005 BSD P4CL :6006
29 – Mar-2005	0.1.10	Andrew Hearn	Update GDD Reports	GDD Reports were added to the document	BSD P4CL : 6189
31 – Mar-2005	0.1.11	John Ryu	Update GDD Reports	Expand Table of Content to include Class Diagram Section headers. Remove Data Type column from the GDD Report. Updated Order Common Definitions.	BSD P4CL : 6301
31 – Mar-2005	0.1.12	Eric Kauz	Update GDD Reports and Models	Trade Item Hazardous Information Abstract Description Short Description Abstract Amount	
07 _ Apr-2005	0.1.13	John Ryu	Added creationDateTime : DateTime in the ResponseDocument class	Detail changes are provided in Summary of Changes 1.5.1.45 Related Requirements 1.5.2.45 GDD 1.5.3.1.5 Class Diagram	MDL P4CL : 6352 BSD P4CL : 6360
24 – Ma-2005	0.2.0	Coen Janssen	Several updates for Upstream Standards and ebMeat + Peer review comments	Detail changes are provided in Summary of Changes	
14 – Jun-2005	0.2.1	Coen Janssen	XML development comments	Added GoodsRequirementsLineItem Fixed some errors	
15 – Jun-2005	0.2.2	Eric Kauz	ebMeat Requirements	Added Extension Point to ItemContainmentClass	
16- Jun-2005	0.2.3	Eric Kauz	Errata	Updated Data Types for MeasurementCode, PackageDescriptionCode Updated Quantity for change to MeasurementCode Date Type. Changed IncoTerm List to Internal Code List	

Date of Change	Version	Changed By	Reason for Change	Summary of Change	Model Build #
20 – Jun-2005	0.2.4	John Ryu	Change Name of CodeList	Based on FTL Load Tender F2F Lawrenceville Meeting DeliverPaymentMethodCodeList→1.5.4.70 TransportationPaymentMethodCodeList	BSD P4CL: 6931
08- Jul-2005	0.2.5	John Ryu	Minor Typographical edits	Section 1.5.4.58 Service Level Code List Section 1.5.3.2.15 corrected typo in DeliverReference	BSD P4CL: 7097
11- Jul-2005	0.2.6	Coen Janssen	Added new class QuantityRange	Needed for BMS Purchase Conditions	BSD P4CL: 7103
21- Jul-2005	0.2.7	Coen Janssen	Technical Design Public Review	Functional changes, Detail changes are provided in Summary of Changes	
19 – Aug-2005	0.2.8	Coen Janssen	Technical Design Public Review	Functional changes, Detail changes are provided in Summary of Changes	
26 – Aug-2005	0.2.9	John Ryu	Technical Design Public Review	Detail changes are provided in Summary of Changes Added CurrencyExchangeRateInformation to Related Requirements/GDD/Class Diagram	MDL P4CL: 7363 BSD P4CL: 7365
13- Sep-2005	0.2.10	Coen Janssen	Technical Design Public Review	Functional changes, Detail changes are provided in Summary of Changes	
03- Oct-2005	0.2.11	Coen Janssen	TDPR Upstream Invoice	Functional changes to Payment Terms, Detail changes are provided in Summary of Changes	
14- Oct-2005	0.2.12	John Ryu	Quality check against reintroduced elements from Document Version 0.2.0—0.2.11	Detail changes are provided in Summary of Changes	BSD P4CL: 7582 MDL P4CL: 7570
01 – Nov-2005	0.2.13	John Ryu	Work from Pay Advanced Remittance Notice	Detail changes are provided in Summary of Changes	BSD P4CL: 7648
15- Nov-2005	0.2.14	Eric Kauz	Add FMCG Trade Item Identification	Detail changes are provided in Summary of Changes	BSD P4CL: 7648
02- Dec-2005	0.2.15	John Ryu	Modified Message Reason List	Detail changes are provided in Summary of Changes	BSD P4CL: 7862
06- Jan-2006	0.2.16	John Ryu	Modified Service Level code List	Detail changes are provided in Summary of Changes	BSD P4CL: 7969
06- Feb-2006	0.2.17	Coen Janssen	Bugfix on version 2.1 (upstream)	Detail changes are provided in Summary of Changes Added new attribute	BSD P4CL: 8022

Date of Change	Version	Changed By	Reason for Change	Summary of Change	Model Build #
14- Feb-2006	0.2.18	John Ryu	Based on Item Implementation Feedback Phase #1 work. BRAD p4cl: 7983	Marked targetMarketDescription for deprecation in the TargetMarketInformation.	BSD / MDL P4CL: 8074
01- Mar-2006	0.2.19	John Ryu	Based on Transportation Rate Response and Reply work	Moved into Deliver Common. Commodity Group and Equipment Information	MDL P4CL: 8123 BSD P4CL: 8124
09- Mar-2006	0.2.20	Esther Peelen	IRT Food & Beverage requirement	Added ExternalFileLink class	MDL P4CL: 8049
15- Mar-2006	0.2.21	John Ryu	Based on Align Item Work	Changed flash point temperature from mandatory to optional. Detail changes are provided in Summary of Changes	MDL/BSD P4CL: 8183
21- Mar-2006	0.2.21	Eric Kauz	IRT Food & Beverage requirement	Added UN_INFODS_Code to Extended Data Types	CL 8213
12- May-2006	0.2.22	John Ryu	Advanced Remittance Notification	Added Payment Discount	MDL 8311 BSD 8340
26- May-2006	0.2.23	John Ryu	Updated For Major Release	Detail changes are provided in Summary of Changes	MDL: 8557 BSD: 8564
15-Mar-2007	0.3.0	John Ryu	Update for BMS Release Version 2.1	Updates to GDD Platform	BSD P4CL: 9066
23- Mar-2007	0.4.0	John Ryu	Updated for BMS Release Version 2.3		BSD P4CL: 9138
03- May-2007	0.4.1	John Ryu	Update based on public review	Detail changes are provided in Summary of Changes	MDL P4CL: 9289 BSD P4CL: 9290
25- May-2007	0.4.2	John Ryu	eCom BRG eballot approved	Updated BMS to approved	BSD p4cl: 9460
16-Jul-2007	0.4.3	Giovanni Biffi and Brian Bennett	Updated the GDD report for the flashPointTemperature to make it optional as it is requested by GDSN MR2 Fixed spelling error on Model Event Tactic	Updates related to GDSN Maintenance Release 2 Quality Assurance	

Date of Change	Version	Changed By	Reason for Change	Summary of Change	Model Build #
17-Jul-2007	0.5.0	John Ryu	Upgrade to BMS Release 2.4.0	Detail changes are provided in Summary of Changes.	MDL P4CL: 9617 BSD P4CL: 9668
02-Aug-2007	0.5.1	John Ryu	Added VAT Tax Extension into common	Detail changes are provided in Summary of Changes.	MDL P4CL: 9701 BSD P4CL: 9702
04-Sep-2007	0.5.2	John Ryu	Part of Stop Gap Report	Detail changes are provided in Summary of Changes.	MDL P4CL: 9910 BSD P4CL: 9913
25-Sep-2007	0.5.3	John Ryu	Part of BMS Release 2.4.0	Updated BMS to approved	BSD P4CL: 10035
1-Dec-2008	0.6.0	John Ryu	BMS Release 2.5.0 Public Review	Noted in summary of changes.	MDL 10752
06-Feb-2009	Issue 0.6.0	Lisa Herrick	BMS Release 2.5.0 eBallot Approved	Noted in summary of changes.	Not Applicable
17-Jul-2009	0.7.0	Lisa Herrick	BMS Release 2.6.0 Initial Release	Noted in Summary of Changes	BSD P4CL: 11180 MDL 11160
28 Jul 2009	0.7.1	Lisa Herrick	BMS Release 2.6.0 TSD Review Updates	Noted in Summary of Changes	MDL 11203 BSD P4CL: 11205
29 Jul 2009	0.7.2	Lisa Herrick	BMS Release 2.6.0 Updates based on BRG comments	Noted in Summary of Changes	P4CL MDL 11212; BSD 11220
14 Aug 2009	0.7.3	Lisa Herrick	BMS Release 2.6.0 Updates based on TSD Review	Noted in Summary of Changes	BSD 11251
30 Oct 2009	0.7.3 Issue	Lisa Herrick	BMS Release 2.6.0 eBallot Approved	Updated to Issue	Not Applicable

Disclaimer

Whilst every effort has been made to ensure that the guidelines to use the GS1 standards contained in the document are correct, GS1 and any other party involved in the creation of the document HEREBY STATE that the document is provided without warranty, either expressed or implied, of accuracy or fitness for purpose, AND HEREBY DISCLAIM any liability, direct or indirect, for damages or loss relating to the use of the document. The document may be modified, subject to developments in technology, changes to the standards, or new legal

requirements. Several products and company names mentioned herein may be trademarks and/or registered trademarks of their respective companies.

Table of Contents

1. Business Solution Design	12
1.1. Problem Statement / Business Need	12
1.2. Objective	12
1.3. Audience	12
1.4. References	12
1.5. Acknowledgements	12
1.5.1. BRG Members	12
1.5.2. Task/Project Group Participants	12
1.5.3. Design Team Members	12
1.5.4. Business Context	13
2. Common Library Common Components	14
2.1. Package Overview: Common Library Common Components	14
2.2. Package Overview: Components	14
2.2.1. Class Diagram: Date and Time	14
2.2.2. GDD Report: Date and Time	14
2.2.3. Class Diagram:	16
2.2.4. GDD Report: Document	16
2.2.5. Class Diagram: Document Reference	17
2.2.6. GDD Report: Document Reference	18
2.2.7. Class Diagram: Quantity Range	19
2.2.8. GDD Report: Quantity Range	19
2.2.9. Class Diagram: Response Document	20
2.2.10. GDD Report: Response Document	20
2.3. Package Overview: Data Type	22
2.3.1. Class Diagram: Data Type	22
2.3.2. GDD Report: Data Type	22
2.4. Package Overview: Compound Data Type	23
2.4.1. Class Diagram Abstract Amount	23
2.4.2. GDD Report: Abstract Amount	23
2.4.3. Class Diagram: Amount	23
2.4.4. GDD Report: Amount	23
2.4.5. Class Diagram: Description	24
2.4.6. GDD Report: Description	24
2.4.7. Class Diagram: Long Description	24
2.4.8. GDD Report: Description	25
2.4.9. Class Diagram: Measurement	25
2.4.10. GDD Report: Measurement	25
2.4.11. Class Diagram: Quantity	26
2.4.12. GDD Report: Quantity	26
2.5. Package Overview: Extended Data Type	27

2.5.1.	Class Diagram: Extended Data Type.....	27
2.5.2.	GDD Report: Extended Data Type.....	27
2.6.	Package Overview: Identification.....	28
2.6.1.	Class Diagram: Entity Identification	28
2.6.2.	GDD Report: Entity Identification	28
2.6.3.	Class Diagram: Party Identification	28
2.6.4.	GDD Report: Party Identification	29
2.6.5.	Class Diagram: Logistic Unit Identification.....	30
2.6.6.	GDD Report: Logistic Unit Identification.....	30
2.6.7.	Class Diagram: Trade Item Identification	31
2.6.8.	GDD Report: Trade Item Identification.....	32
2.6.9.	Class Diagram: Typed Entity Identification	33
2.6.10.	GDD: Typed Entity Identification	33
3.	Common Library Process Common Components	34
3.1.	Package Overview Common Library Process Components.....	34
3.2.	Package Overview: Deliver Common	34
3.2.1.	Class Diagram: Deliver Date Information.....	34
3.2.2.	GDD Report: Deliver Date Information.....	34
3.2.3.	Class Diagram: Transactional Item Data	35
3.2.4.	GDD Report: Transactional Item Data	35
3.2.5.	Class Diagram: Unit Measurement	37
3.2.6.	GDD Report: Unit Measurement	37
3.3.	Package Overview: Order Common	37
3.3.1.	Class Diagram: Order Header Indicator.....	37
3.3.2.	GDD Report: Order Header Indicator.....	38
3.3.3.	Class Diagram: Order Logistical Information	39
3.3.4.	GDD Report: Order Logistical Information	40
3.3.5.	Class Diagram: Order Party Information	44
3.3.6.	GDD Report: Order Party Information.....	44
3.3.7.	Class Diagram: Simple Order Line Item.....	46
3.3.8.	GDD Report: Simple Order Line Item	46
3.3.9.	Class Diagram: Shipment Detail	48
3.3.10.	GDD Report: Shipment Detail	48
3.3.11.	Class Diagram: Trade Agreement.....	50
3.3.12.	GDD Report: Trade Agreement.....	50
3.4.	Package Overview: Pay Common	51
3.4.1.	Class Diagram: Financial Institution Information.....	51
3.4.2.	GDD Report: Financial Institution Information.....	51
3.4.3.	Class Diagram: Invoice Allowance Charge	53
3.4.4.	GDD Report: Invoice Allowance Charge.....	53
3.4.5.	Class Diagram: Invoice Party	54
3.4.6.	GDD Report: Invoice Party.....	55
3.4.7.	Class Diagram: Invoice Tax Information	56
3.4.8.	GDD Report: Invoice Tax Information	56

3.4.9.	Class Diagram: Payment Method.....	57
3.4.10.	GDD Report: Payment Method	57
3.5.	Package Overview: Process Common	58
3.5.1.	Class Diagram: Contact	58
3.5.2.	GDD Report: Contact	58
3.5.3.	Class Diagram: Currency Exchange Rate Information	59
3.5.4.	GDD Report: Currency Exchange Rate Information	59
3.5.5.	Class Diagram: Name and Address.....	61
3.5.6.	GDD Report: Name and Address.....	61
3.5.7.	Class Diagram: Shipment Transportation Information	64
3.5.8.	GDD Report: Shipment Transportation Information	64
3.6.	Package Overview: Terms.....	66
3.6.1.	Class Diagram: Allowance Charge	66
3.6.2.	GDD Report: Allowance Charge	67
3.6.3.	Class Diagram: Payment Terms	70
3.6.4.	GDD Report: Payment Terms	71
4.	Code Lists	73
4.1.	AccountNumberTypeList.....	73
4.2.	AdditionalPartyIdentificationList	74
4.3.	AdditionalTradeItemIdentificationList	75
4.4.	AllowanceChargeList	76
4.5.	AllowanceOrChargeList	77
4.6.	ApplicationReceiptAcknowledgementStatusList.....	77
4.7.	CreditReasonCodeList	77
4.8.	DocumentCommandList.....	78
4.9.	DocumentStatusList	79
4.10.	EffectiveDateList	79
4.11.	ErrorOrWarningList	79
4.12.	InvoiceTypeCodeList.....	83
4.13.	MeasurementTypeCodeList.....	83
4.14.	NonBinaryLogicCodeList.....	84
4.15.	PaymentFormatList	84
4.16.	PaymentMethodList	84
4.17.	PaymentTermsEventList.....	85
4.18.	PaymentTermsTypeList	86
4.19.	ResponseStatusList	87
4.20.	ServiceLevelCodeList	87
4.21.	SettlementList	88
4.22.	ShipmentSpecialHandlingCodeList.....	88
4.23.	TimePeriodList	90
4.24.	TransportationMethodTypeCodeList.....	90
4.25.	VATCategoryCodeList	92
4.26.	VATPaymentDueList.....	93



5. Summary of Changes.....94

1. Business Solution Design

1.1. Problem Statement / Business Need

1.2. Objective

The objective to develop this common library is to enable the following.

- Contain and maintain all reusable data elements available in the GS1 BMS Standards.
- Standardize the design and development process to produce consistent and quality products.
- Aids and protects the integrity of the GBM
- Gives visibility to internal development staff and external users to our available reusable components.

1.3. Audience

The primary audience for this document are individuals assigned as GS1 Business Process Analysts, Business Requirements Groups Managers, GDD Managers, and XML System Developers who are responsible for the completion and delivery of the Business Message Standards.

The secondary audience for this document are users involved in the GSMP activities with BRG.

1.4. References

Reference Name	Description
GS1 Modeling Best Practices Version 0.6.0 for Publication 2.0	
eb Methodology	

1.5. Acknowledgements

1.5.1. BRG Members

Function	Name	Company
None		

1.5.2. Task/Project Group Participants

Function	Name	Company / organisation
Participant	None	

1.5.3. Design Team Members

Function	Name	Organisation
Modeller	Lisa Herrick	GS1 Global Office

Function	Name	Organisation
XML Technical Designer	Dipan Anarkat	GS1 Global Office
Peer Reviewer	John Ryu	GS1 Global Office

1.5.4. Business Context

Context Category	Value(s)
Industry	All
Geopolitical	All
Product	All
Process	All
System Capabilities	All
Official Constraints	None

2. Common Library Common Components

2.1. Package Overview: Common Library Common Components

2.2. Package Overview: Components

2.2.1. Class Diagram: Date and Time

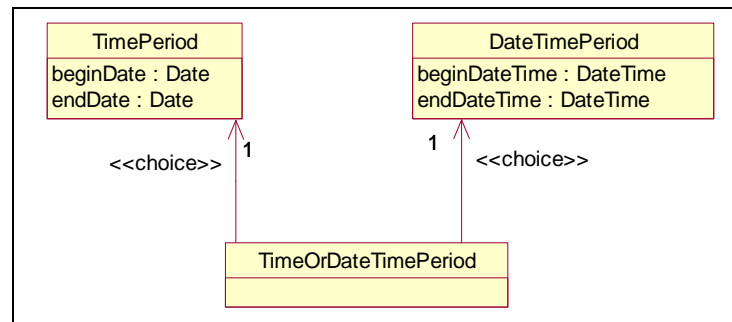

2.2.2. GDD Report: Date and Time

Class (ABIE)	Attribute (BBIE)	Association (ASBIE)	Secondary Class	Official Dictionary Entry Name	Definition	Multiplicity	Data Type Components	Related Requirements	Facets
DateTimePeriod				Date Time_ Time Period. Details	Definition Not Found				
	beginDateTime			Date Time_ Time Period. Begin Date Time_ Date Time. Code	The date and time on which this event begins	1..1	Code. Content Code List. Agency. Identifier Code List. Agency Name. Text		Facets constrained by code list values
	endDateTime			Date Time_ Time Period. End Date Time_ Date Time. Code	The date and time on which this event ends	1..1	Code. Content Code List. Agency. Identifier Code List. Agency Name. Text		Facets constrained by code list values

Class (ABIE)	Attribute (BBIE)	Association (ASBIE)	Secondary Class	Official Dictionary Entry Name	Definition	Multiplicity	Data Type Components	Related Requirements	Facets
TimeOrDateTimePeriod				Time Or Date Time Period. Details	Allows for the selection of time period which only includes date or Date Time Period which includes both date and time.				
			DateTimePeriod	Time Or Date Time Period. Choice Association. Date Time_ Time Period	The time or date time period is represented in date time format.	1..1			
			TimePeriod	Time Or Date Time Period. Choice Association. Date_ Time Period	The time or date time period is represented in date format without time.	1..1			
TimePeriod				Date_ Time Period. Details	Definition Not Found				
	beginDate			Date_ Time Period. Begin Date. Date_ Date Time	The date and time on which this event begins	1..1	Date Time. Content		Facets constrained by code list values
	endDate			Date_ Time Period. End Date. Date_ Date Time	The date and time on which this event ends	1..1	Date Time. Content		Facets constrained by code list values

2.2.3. Class Diagram:

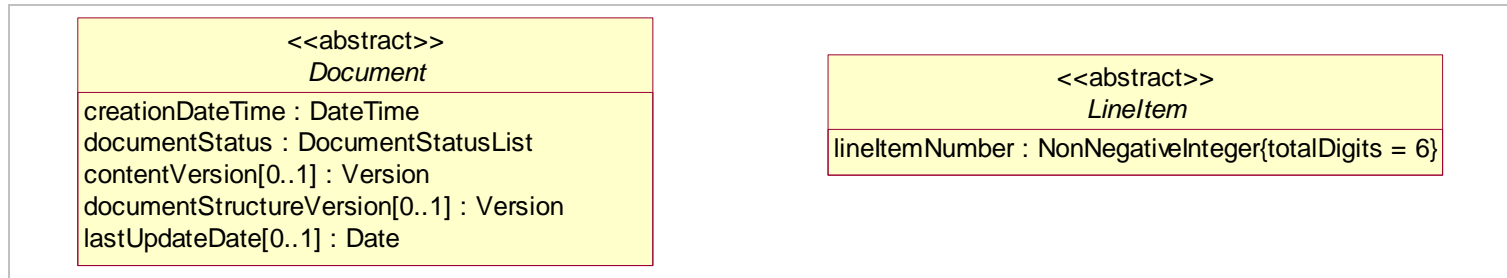

2.2.4. GDD Report: Document

Class (ABIE)	Attribute (BBIE)	Association (ASBIE)	Secondary Class	Official Dictionary Entry Name	Definition	Multiplicity	Data Type Components	Related Requirements	Facets
Document				Electronic_ Document. Details	Used to specify basic information about the content of the message including version number, creation date and time.				
	contentVersion			Electronic_ Document. Content_ Version. Identifier	This is a version number for the content of the document.	0..1	Identification Scheme Agency. Identifier Identification Scheme Agency. Name. Text Identification Scheme Uniform Resource. Identifier		No restrictions
	creationDateTime			Electronic_ Document. Creation_ Date. Date Time	This is the date the message was created. The format is 'YYYYMMDDTHHMMSS'. This date is recommended to use as technical information	1..1	Date Time. Content Date Time. Format. Text		No restrictions
	documentStatus			Electronic_ Document. Status. Identifier	Indicates if the document is a copy or an original.	1..1	Identification Scheme Agency. Identifier Identification Scheme Agency. Name. Text Identification Scheme Uniform Resource. Identifier		No restrictions

Class (ABIE)	Attribute (BBIE)	Association (ASBIE)	Secondary Class	Official Dictionary Entry Name	Definition	Multiplicity	Data Type Components	Related Requirements	Facets
	documentStructureVersion			Electronic_ Document. Document Structure_ Version. Identifier	This is a version number for the structure of the document.	0..1	Identification Scheme Agency. Identifier Identification Scheme Agency. Name. Text Identification Scheme Uniform Resource. Identifier		No restrictions
	lastUpdateDate			Electronic_ Document. Last Update_ Date. Identifier	This is the last update date for the specific document. The format is 'YYYY-MM-DD'.	0..1	Identification Scheme Agency. Identifier Identification Scheme Agency. Name. Text Identification Scheme Uniform Resource. Identifier		No restrictions
LineItem				Line Item. Details	This external class originates from Document.				
	lineItemNumber			Line Item. Number. Numeric	Sequence number that identifies the line.	1..1	Numeric. Content Numeric. Format. Text		totalDigits='6'

2.2.5. Class Diagram: Document Reference

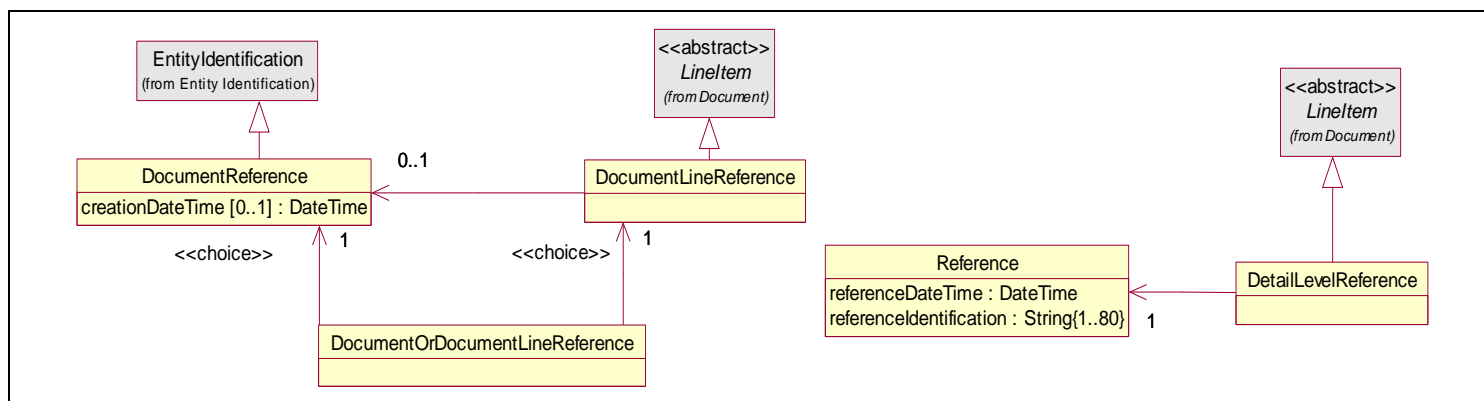

2.2.6. GDD Report: Document Reference

Class (ABIE)	Attribute (BBIE)	Association (ASBIE)	Secondary Class	Official Dictionary Entry Name	Definition	Multi plicity	Data Type Components	Related Requirements	Facets
DetailLevelReference				Despatch Advice_Line Item_ Detail Level Reference. Details	This class was included to accommodate the requirement for identifying the reference document line number per despatch advice line number. It does this using it's associations with ItemContainment and its association with Reference.				
			Reference	Despatch Advice_Line Item_ Detail Level Reference. Association. Entity Reference	This information on Reference for DetailLevelReference.	1..1			
DocumentLineReference				Document Line Reference. Details	Reference to another GS1 Business Message Line.				
			DocumentReference	Document Line Reference. Association. Document Reference	Identification of the business document to which the line belongs.	0..1			
			LineItem	Document Line Reference. Inheritance. Line Item	Identification of the referenced document line.	1..1			
DocumentOrDocumentLineReference				Document Or Document Line Reference. Details	Reference to another GS1 Business Message or Business Message Line.				
		purchaseConditionsDocumentOrDocumentLineReference	DespatchAdvice	Document Or Document Line Reference. Association. Despatch Advice		0..1			
		purchaseOrderDocumentOrDocumentLineReference	DespatchAdvice	Document Or Document Line Reference. Purchase Order Document Or Document Line Reference. Despatch Advice		0..1			
			DocumentLineReference	Document Or Document Line Reference. Choice_ Association. Document Line Reference	Provides the Document Line Reference information.	1..1			

Class (ABIE)	Attribute (BBIE)	Association (ASBIE)	Secondary Class	Official Dictionary Entry Name	Definition	Multiplicity	Data Type Components	Related Requirements	Facets
			DocumentReference	Document Or Document Line Reference. Choice_Association. Document Reference	Provides the Document Reference information.	1..1			
DocumentReference				Document Reference. Details	Reference to another GS1 Business Document.				
	creationDateTime			Document Reference. Creation_ Date Time. Date Time	Date and time of creation of the referenced document.	0..1	Date Time. Content Date Time. Format. Text		No restrictions
			EntityIdentification	Document Reference. Association. Entity Identification	Identification of the referenced business document.	1..1			
Reference				Entity Reference. Details	Information with regards to a referenced document or message.				
	referenceDateTime			Entity Reference. Date. Date Time	The date, time or date time related to a referenced document or message.	1..1	Date Time. Content Date Time. Format. Text		Facets constrained by code list values
	referenceIdentification			Entity Reference. Identification. Text	Unique identification of the entity referenced.	1..1	Text. Content		minLength='1' maxLength='80'

2.2.7. Class Diagram: Quantity Range

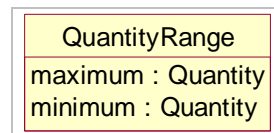

2.2.8. GDD Report: Quantity Range

Class (ABIE)	Attribute (BBIE)	Association (ASBIE)	Secondary Class	Official Dictionary Entry Name	Definition	Multiplicity	Data Type Components	Related Requirements	Facets
QuantityRange				Quantity Range. Details	Provides the difference or interval between the minimum and				

					maximum value which may include the associated unit of measure.				
	maximum			Quantity Range. Maximum. Quantity	Specifies the upper limit of the quantity range.	1..1	Quantity. Content Quantity Unit. Code Quantity Unit. Code List Agency. Identifier		No Restrictions
	minimum			Quantity Range. Minimum. Quantity	Specifies the lower limit of the quantity range.	1..1	Quantity. Content Quantity Unit. Code Quantity Unit. Code List Agency. Identifier		No Restrictions

2.2.9. Class Diagram: Response Document

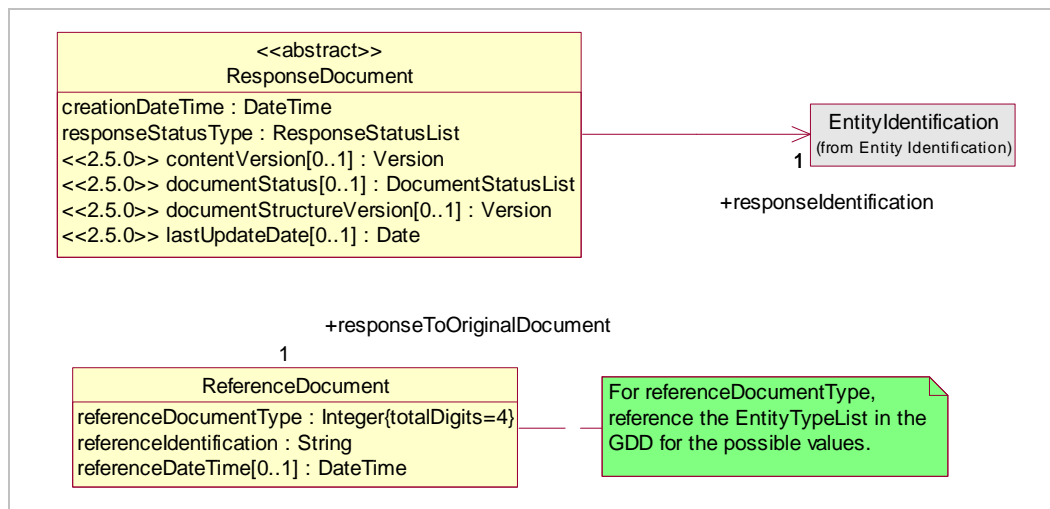

2.2.10. GDD Report: Response Document

Class (ABIE)	Attribute (BBIE)	Association (ASBIE)	Secondary Class	Official Dictionary Entry Name	Definition	Multiplicity	Data Type Components	Related Requirements	Facets
ReferenceDocument				Reference Document. Details	Contains the identification and date of the document referenced.				
	referenceDateTime			Reference Document.Reference Date Time.Date	Provides the date and optional time for referenced document.	0..1	Date Time. Content Date Time. Format. Text		No restrictions

Class (ABIE)	Attribute (BBIE)	Association (ASBIE)	Secondary Class	Official Dictionary Entry Name	Definition	Multiplicity	Data Type Components	Related Requirements	Facets
				Time					
	referenceDocumentType			Reference Document. Type. Numeric	Unique type of document referenced.	1..1	Numeric. Content Numeric. Format. Text		totalDigits='4'
	referenceIdentification			Reference Document. Identification. Text	Unique identification of the document referenced.	1..1	Text. Content		No Restrictions
ResponseDocument				Response Document. Details	Specifies the type of response and the information of the referenced document.				
	contentVersion			Response Document.Content Version.Version_Identifier	This is a version number for the content of the document.	0..1	Identifier. Content		
	creationDateTime			Response Document.Creation Date Time.Date Time	The date and time the response document was created.	1..1	Date Time. Content Date Time. Format. Text		
	documentStatus			Response Document.Document Status.Document Status_ Code	Provides the status of the document.	0..1	Code. Content		
	documentStructureVersion			Response Document.Document Structure Version.Version_Identifier	This is a version number for the structure of the document.	0..1	Identifier. Content		
	lastUpdateDate			Response Document.Last Update Date.Date_ Date Time	This is the last update date for the specific document. The format is 'YYYY-MM-DD'.	0..1	Date Time. Content		
	responseStatusType			Response Document. Response Status Type. Code	Unique type of response to a document referenced.	1..1	Code. Content Code List. Agency. Identifier Code List. Agency Name. Text		Facets constrained by code list values
		responseIdentification	EntityIdentification	Response Document.	The identification of the response document.	1..1			

Class (ABIE)	Attribute (BBIE)	Association (ASBIE)	Secondary Class	Official Dictionary Entry Name	Definition	Multiplicity	Data Type Components	Related Requirements	Facets
		on		Response Identification_ Association. Entity Identification					
		responseToOriginal Document	Reference Document	Response Document. Association. Reference Document	Contains the identification and date of the original document referenced.	1..1			

2.3. Package Overview: Data Type

2.3.1. Class Diagram: Data Type

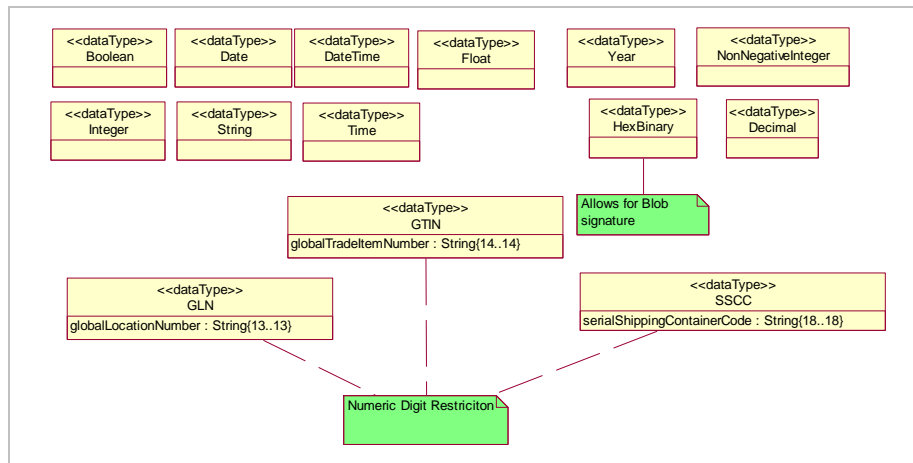

2.3.2. GDD Report: Data Type

GDD report for Data type is not applicable.

2.4. Package Overview: Compound Data Type

2.4.1. Class Diagram Abstract Amount

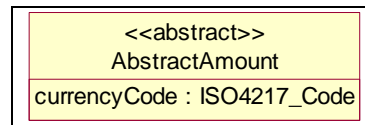

2.4.2. GDD Report: Abstract Amount

Class (ABIE)	Attribute (BBIE)	Association (ASBIE)	Secondary Class	Official Dictionary Entry Name	Definition	Multiplicity	Data Type Components	Related Requirements	Facets
AbstractAmount				Abstract Amount. Details	n/a				
	currencyCode			Abstract Amount. Currency Code. ISO4217_Code	N/A	1..1	Code. Content		Facets constrained by code list values

2.4.3. Class Diagram: Amount

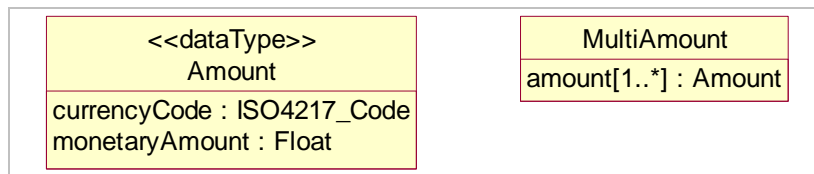

2.4.4. GDD Report: Amount

Class (ABIE)	Attribute (BBIE)	Association (ASBIE)	Secondary Class	Official Dictionary Entry Name	Definition	Multiplicity	Data Type Components	Related Requirements	Facets
MultiAmount				Multi-currency Amount. Details	Provides multiple iterations of monetary amount and an				

					associated currency code.				
	amount			Multi-currency Amount. Amount. Numeric	Quantity of money	1..*	Numeric. Content Numeric. Format. Text		No Restrictions

2.4.5. Class Diagram: Description

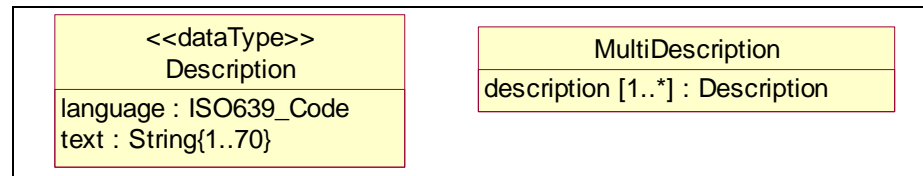

2.4.6. GDD Report: Description

Class (ABIE)	Attribute (BBIE)	Association (ASBIE)	Secondary Class	Official Dictionary Entry Name	Definition	Multiplicity	Data Type Components	Related Requirements	Facets
MultiDescription				Multi Description. Details	Provides multiple iterations of descriptive text with a maximum length of 70 and an associated language code.				
	description			Multi Description. Description. Text	A systematic means of communicating by the use of sounds or conventional symbols.	1..*	Text. Content		Unbounded

2.4.7. Class Diagram: Long Description

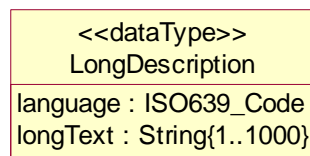

2.4.8. GDD Report: Description

No GDD Report for DataTypes

2.4.9. Class Diagram: Measurement

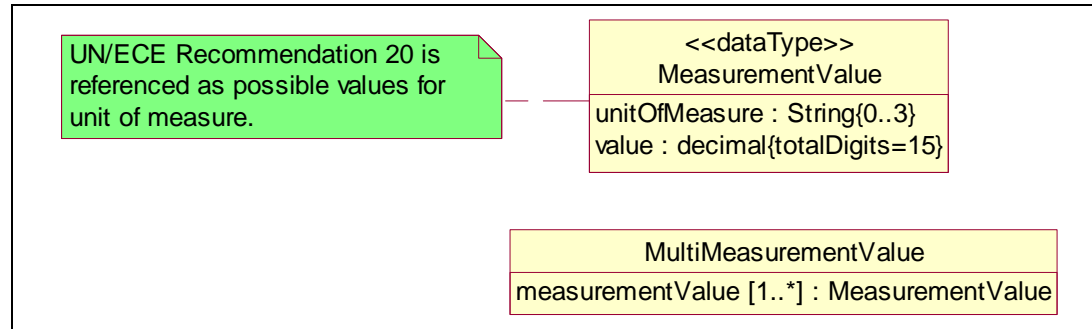

2.4.10. GDD Report: Measurement

Class (ABIE)	Attribute (BBIE)	Association (ASBIE)	Secondary Class	Official Dictionary Entry Name	Definition	Multiplicity	Data Type Components	Related Requirements	Facets
MultiMeasurementValue				Multi Measurement Value. Details	Provides multiple iterations of measurement value and an associated unit of measure code.				
	measurementValue			Multi Measurement Value. Measurement Value. Measure	Provides the measurement value with the corresponding unit of measure.	1..*	Measure. Content Measure Unit. Code Measure Unit. Code List Version. Identifier		No Restrictions Facets constrained by code list values

2.4.11. Class Diagram: Quantity

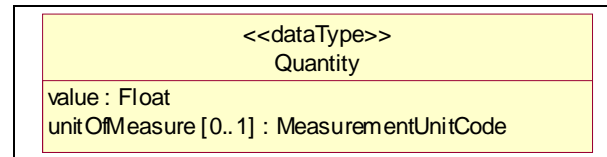

2.4.12. GDD Report: Quantity

GDD report for Data type is not applicable.

2.5. Package Overview: Extended Data Type

2.5.1. Class Diagram: Extended Data Type

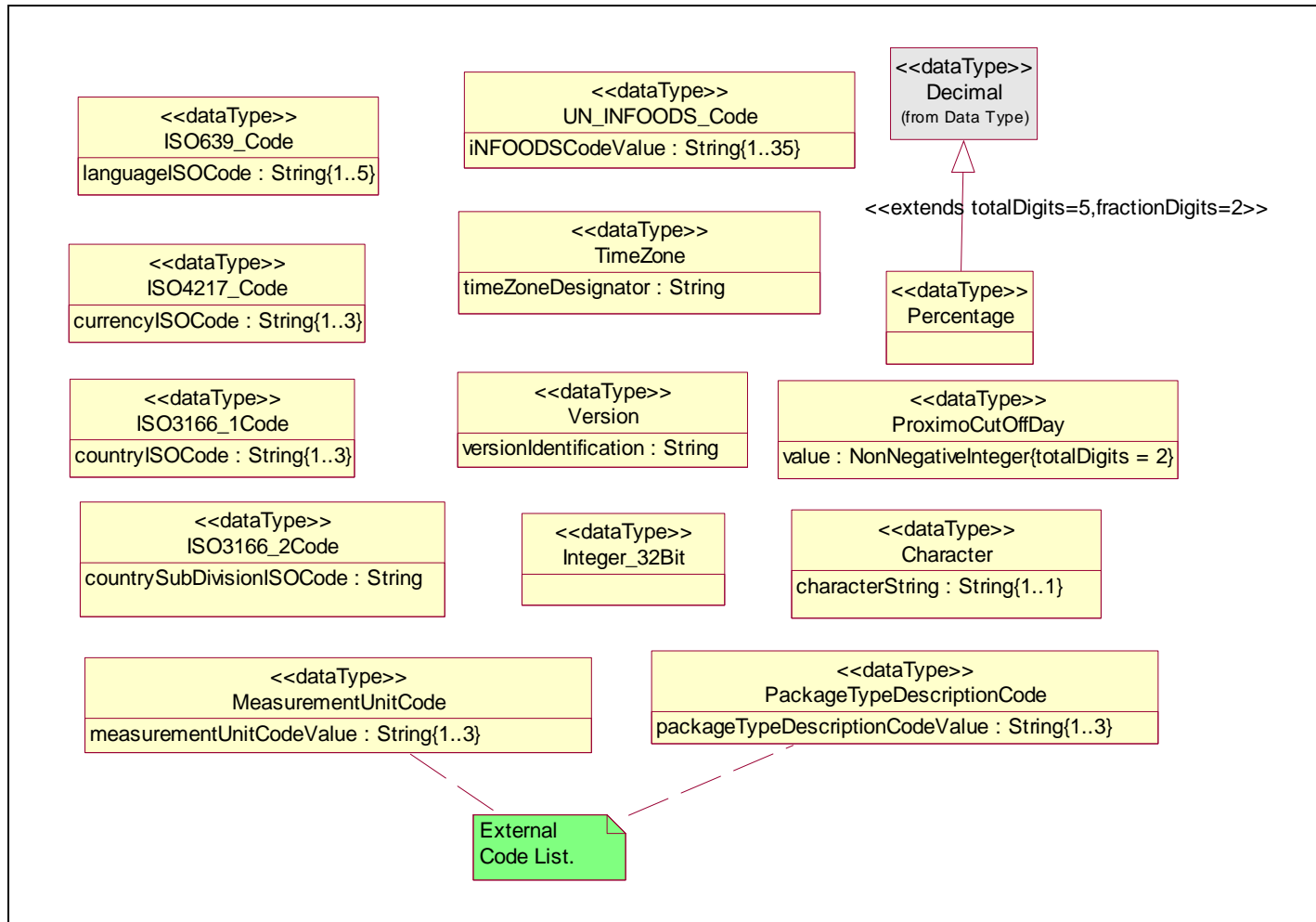

2.5.2. GDD Report: Extended Data Type

GDD report for Extended Data type is not applicable.

2.6. Package Overview: Identification

2.6.1. Class Diagram: Entity Identification

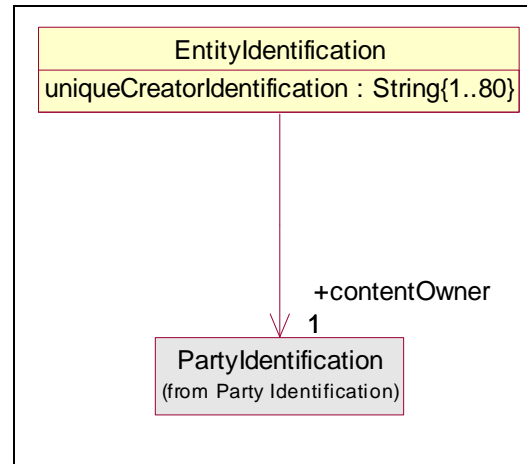

2.6.2. GDD Report: Entity Identification

Class (ABIE)	Attribute (BBIE)	Association (ASBIE)	Secondary Class	Official Dictionary Entry Name	Definition	Multi plicity	Data Type Components	Related Requirements	Facets
EntityIdentifi cation				Entity Identification. Details	The unique identification of a document.				
	uniqueCreatorId entification			Entity Identification. Identification. Text	The unique creator identification for the message.	1..1	Text. Content		minLength=' 1' maxLength=' 80'
		contentOwner	PartyIdentifi cation	Entity Identification. Content Owner. Party Identification	Uniquely identifies the creator of the instance document.	1..1			

2.6.3. Class Diagram: Party Identification

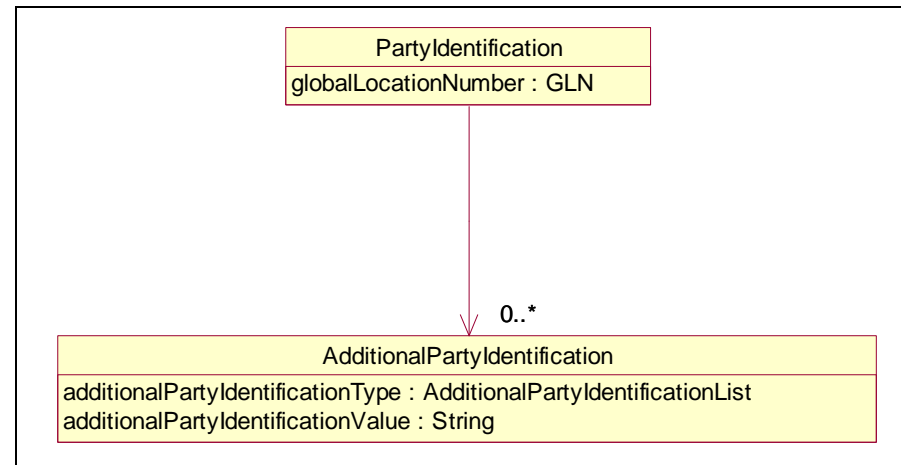

2.6.4. GDD Report: Party Identification

Class (ABIE)	Attribute (BBIE)	Association (ASBIE)	Secondary Class	Official Dictionary Entry Name	Definition	Multiplicity	Data Type Components	Related Requirements	Facets
AdditionalPartyIdentification				Non GLN_ Party Identification. Details	Only one primary party identifier is used for each party. If an alternate identifier, other than GLN is used, there is no guarantee of data integrity across the process. It is the responsibility of the company electing the choice to ensure data integrity.				
	additionalPartyIdentificationType			Non GLN_ Party Identification. Identification Type. Code	Identification of a party by use of a code other than the Global Location Number.	1..1	Code. Content Code List. Agency. Identifier Code List. Agency Name. Text		Facets constrained by code list values
	additionalPartyIdentificationValue			Non GLN_ Party Identification. Identification. Text	A party identifier that is in addition to the GLN.	1..1	Text. Content		No Restrictions
PartyIdentification				Party Identification. Details	Unique location number identifying the Party for which the rest of the message defines.				
	globalLocationNumber			Party Identification. Primary_	The Global Location Number (GLN) is a structured Identification of a physical location, legal or functional entity within an	1..1	Code. Content Code List. Agency.		Facets constrained

Class (ABIE)	Attribute (BBIE)	Association (ASBIE)	Secondary Class	Official Dictionary Entry Name	Definition	Multiplicity	Data Type Components	Related Requirements	Facets
				Identification. GLN_ Identifier	enterprise. The GLN is the primary party identifier. Each party identified in the trading relationship must have a primary party Identification.		Identifier Code List. Agency Name. Text		by code list values
			Additional Party Identification	Party Identification. Additional. Non GLN_ Party Identification	Provides the optional additional formats of party identification	0..*			

2.6.5. Class Diagram: Logistic Unit Identification

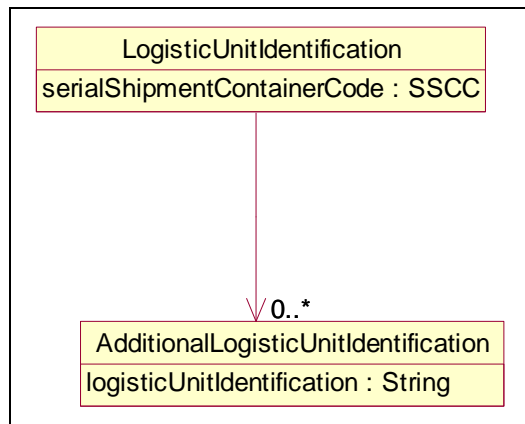

Note: CR will be submitted to align the attribute serialShipmentContainerCode to General Specification for next MAJOR release.

2.6.6. GDD Report: Logistic Unit Identification

Class (ABIE)	Attribute (BBIE)	Association (ASBIE)	Secondary Class	Official Dictionary Entry Name	Definition	Multiplicity	Data Type Components	Related Requirement	Facets
--------------	------------------	---------------------	-----------------	--------------------------------	------------	--------------	----------------------	---------------------	--------

								s	
Additional Logistic Unit Identification				Additional Logistic Unit Identification. Details	Additional (non-SSCC) identification attached to a shipping container or shipping package and used for logistical and traceability purposes.				
	logisticUnitIdentification			Additional Logistic Unit Identification. Logistic Unit Identification. Text	A number which identifies shipping containers or shipping packages.	1..1	Text. Content		No restrictions
Logistic Unit Identification				Logistic Unit Identification. Details	The globally unique identification attached to a shipping container or shipping package and used for logistical and traceability purposes.				
	serialShipmentContainerCode			Logistic Unit Identification. Serial Shipping Container Code. SSCC_Identifier	A single globally unique serial number which identifies shipping containers or shipping packages.	1..1	Identifier. Content		pattern='\d{18}'
			Additional Logistic Unit Identification	Logistic Unit Identification. Association. Additional Logistic Unit Identification	Additional identification(s) attached to a shipping container or shipping package.	0..*			

2.6.7. Class Diagram: Trade Item Identification

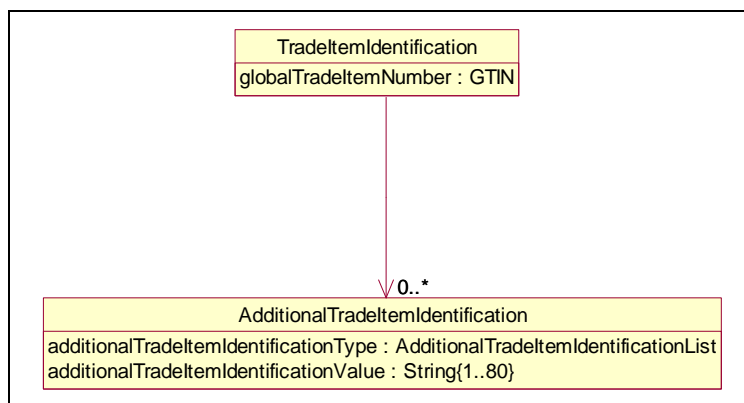

2.6.8. GDD Report: Trade Item Identification

Class (ABIE)	Attribute (BBIE)	Association (ASBIE)	Secondary Class	Official Dictionary Entry Name	Definition	Multiplicity	Data Type Components	Related Requirements	Facets
AdditionalTradeItemIdentification				Non GTIN_ Trade Item Identification. Details	This optional code will be used to cross-reference the Vendors internal trade item number to the GTIN in a one to one relationship.				
	additionalTradeItemIdentificationType			Non GTIN_ Trade Item Identification. Identification Type. Code	Type of the identification system that is being used as an alternative to the Global Trade Item Number.	1..1	Code. Content Code List. Agency. Identifier Code List. Agency Name. Text		Facets constrained by code list values
	additionalTradeItemIdentificationValue			Non GTIN_ Trade Item Identification. Additional Trade Item Identification Value_ additional Trade Item Identification. Text	Alternative means to the Global Trade Item Number to identify a trade item.	1..1	Text. Content		minLength='1' maxLength='80'
TradeItemIdentification				Trade Item Identification. Details	Provides the GTIN as the unique identifier for the item and optionally additional formats of non GTIN identifiers for the item.				
	globalTradeItemNumber			Trade Item Identification. Primary_ Identification. GTIN_ Identifier	A particular Global trade item Number, a numerical value used to uniquely identify a trade item. A trade item is any trade item (trade item or service) upon which there is a need to retrieve pre-defined information and that may be planned, priced, ordered, delivered and or invoiced at any point in any supply chain.	1..1	Code. Content Code List. Agency. Identifier Code List. Agency Name. Text		Facets constrained by code list values
			AdditionalTradeItemIdentification	Trade Item Identification. Additional. Non GTIN_ Trade Item Identification	This information on AdditionalTradeItemIdentification for TradeItemIdentification.	0..*			

2.6.9. Class Diagram: Typed Entity Identification

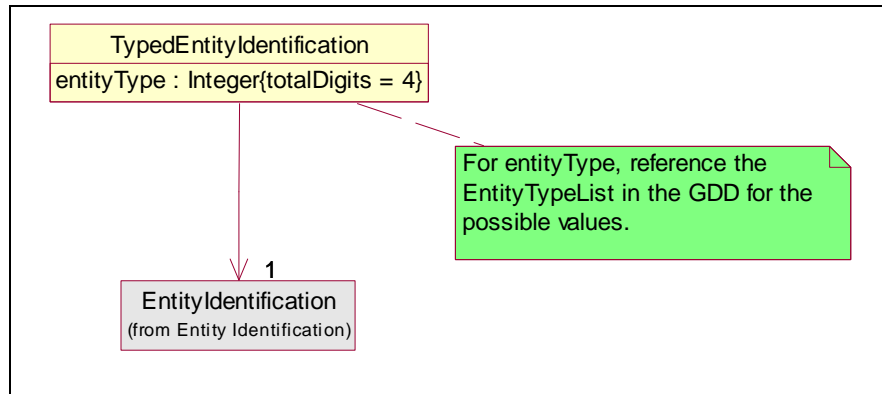

2.6.10. GDD: Typed Entity Identification

Class (ABIE)	Attribute (BBIE)	Association (ASBIE)	Secondary Class	Official Dictionary Entry Name	Definition	Multiplicity	Data Type Components	Related Requirements	Facets
TypedEntityIdentification				Typed_ Entity Reference. Details	Identifies the type of document and provide a unique identifier.				
	entityType			Typed_ Entity Reference. Entity Type. Integer_ Numeric	Identifies from a pre-defined list, the class of document that is referenced.	1..1	Numeric. Content		totalDigits='4'
			EntityIdentification	Typed_ Entity Reference. Association. Entity Identification	This information on EntityIdentification for TypedEntityIdentification.	1..1			

3. Common Library Process Common Components

3.1. Package Overview Common Library Process Components

3.2. Package Overview: Deliver Common

3.2.1. Class Diagram: Deliver Date Information

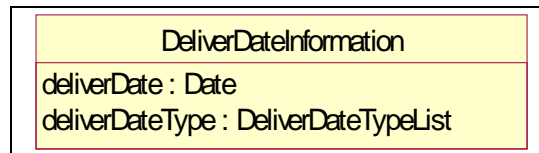

3.2.2. GDD Report: Deliver Date Information

Class (ABIE)	Attribute (BBIE)	Association (ASBIE)	Secondary Class	Official Dictionary Entry Name	Definition	Multiplicity	Data Type Components	Related Requirements	Facets
DeliverDateInformation				Deliver_ Date. Details	Provides the date information for the shipment.				
	deliverDate			Deliver_ Date. Delivery Date. Date_ Date Time	The date on which the shipment is delivered	1..1	Date Time. Content		Facets constrained by code list values
	deliverDateType			Deliver_ Date. Delivery Date_ Type. Code	A code identifying the type of date on which goods or services will or have been delivered.	1..1	Code. Content Code List. Agency. Identifier Code List. Agency Name. Text		Facets constrained by code list values

3.2.3. Class Diagram: Transactional Item Data

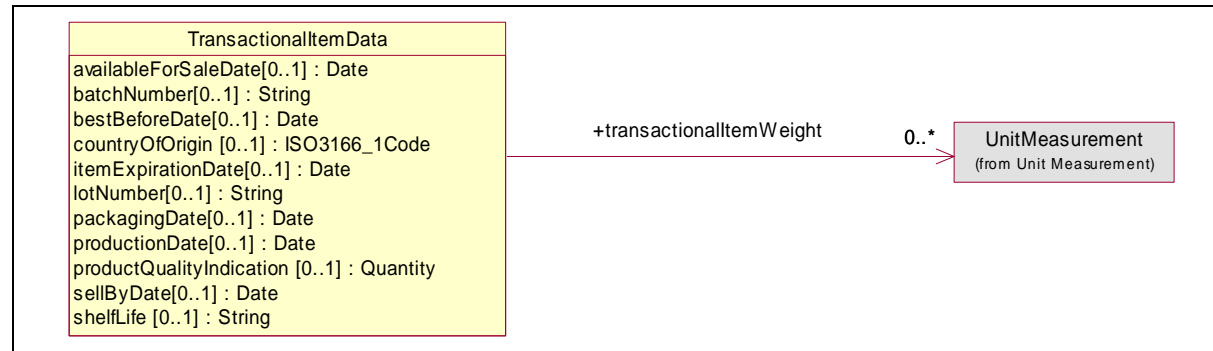

3.2.4. GDD Report: Transactional Item Data

Class (ABIE)	Attribute (BBIE)	Association (ASBIE)	Secondary Class	Official Dictionary Entry Name	Definition	Multiplicity	Data Type Components	Related Requirements	Facets
TransactionalItemData				Transactional_ Trade Item Containment Line. Details	Provides the transactional item data information.				
	availableForSaleDate			Transactional_ Trade Item Containment Line. Available For Sale Date. Date Time	Date - The date the item is available for sale represented in CCYY-MM-DD.	0..1	Text. Content		Unbounded
	batchNumber			Transactional_ Trade Item Containment Line. Batch Number. Text	A batch unites products or items that have undergone or are grouped together to undergo the same transformation process, not necessarily a production process.	0..1	Text. Content		Unbounded
	bestBeforeDate			Transactional_ Trade Item Containment Line. Best Before Date. Date_ Date Time	Ideal consumption or best effective use date of a product.	0..1	Date Time. Content		No restrictions
	countryOfOrigin			Transactional_ Trade Item Containment Line. Of Origin_ Country. ISO_ Country_ Code	Country from which the goods are supplied.	0..1	Code. Content		Facets constrained by code list values
	itemExpirationDate			Transactional_ Trade Item Containment Line. Item Expiration_ Date. Date_ Date Time	Date - The maximum durability of an item CCYY-MM-DD. The format is ISO 8601 CCYY-MM-DD for all data types.	0..1	Date Time. Content		Unbounded

Class (ABIE)	Attribute (BBIE)	Association (ASBIE)	Secondary Class	Official Dictionary Entry Name	Definition	Multiplicity	Data Type Components	Related Requirements	Facets
	lotNumber			Transactional_ Trade Item Containment Line. Lot Number. Text	A distinctive combination of numbers and/or letters from which the complete history of the manufacture, processing, packaging, coding and distribution of a batch can be determined.	0..1	Text. Content		Unbounded
	packagingDate			Transactional_ Trade Item Containment Line. Packaging Date. Date_ Date Time	The date on which the packaging of a product took place.	0..1	Date Time. Content		No restrictions
	productionDate			Transactional_ Trade Item Containment Line. Production Date. Date Time	Date - The date that the product was produced.	0..1	Text. Content		Unbounded
	productQualityIndication			Transactional_ Trade Item Containment Line. Product Quality Indication. Quantity Type Code_ Code	Number used to indicate the quality of a specific batch of products. Optionally a Unit of Measure can be specified, which means that the number is expressed per unit. Example: 100 GRM means 100 per gram.	0..1	Code. Content		Facets constrained by code list values
	sellByDate			Transactional_ Trade Item Containment Line. Sell By Date. Date_ Date Time	Date - Maximum durability date of an item CCYY-MM-DD.	0..1	Date Time. Content		Unbounded
	shelfLife			Transactional_ Trade Item Containment Line. Shelf Life. Text	The length of time a material; substance; product; or reagent can be stored under specified environmental conditions and continue to meet all applicable specification requirements and/or remain suitable for its intended function.	0..1	Text. Content		Unbounded
		transactionalItemWeight	UnitMeasurement	Transactional_ Trade Item Containment Line. Transactional Item Weight_ Association. Unit Measurement	Weight is a measurement of the gravitational force acting on a transactional object.	0..*			

3.2.5. Class Diagram: Unit Measurement

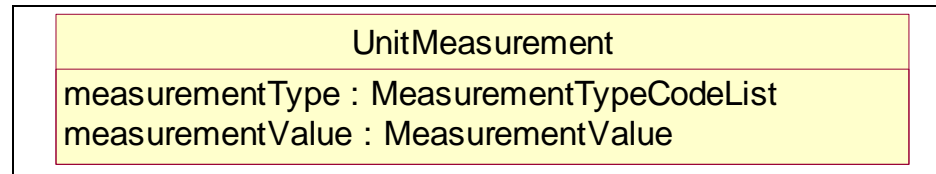

3.2.6. GDD Report: Unit Measurement

Class (ABIE)	Attribute (BBIE)	Association (ASBIE)	Secondary Class	Official Dictionary Entry Name	Definition	Multiplicity	Data Type Components	Related Requirements	Facets
UnitMeasurement				Unit Measurement. Details	Information specifying the weight or volume of a unit.				
	measurementType			Unit Measurement. Measurement Type. Code	Specification of the attribute measured	1..1	Code. Content Code List. Agency. Identifier Code List. Agency Name. Text		Facets constrained by code list values
	measurementValue			Unit Measurement. Measurement Value. Measure	Value of the attribute measured.	1..1	Measure. Content Measure Unit. Code Measure Unit. Code List Version. Identifier		No Restrictions Facets constrained by code list values

3.3. Package Overview: Order Common

3.3.1. Class Diagram: Order Header Indicator

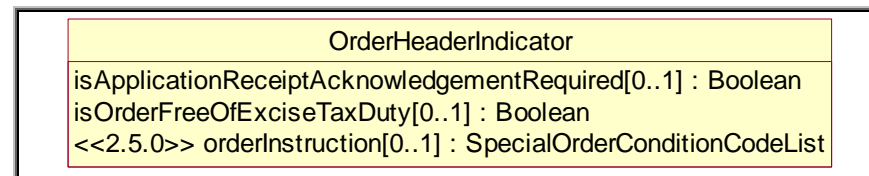

3.3.2. GDD Report: Order Header Indicator

Class (ABIE)	Attribute (BBIE)	Association (ASBIE)	Secondary Class	Official Dictionary Entry Name	Definition	Multiplicity	Data Type Components	Related Requirements	Facets
OrderHeaderIndicator				Order Header Indicator. Details	Provides the order header information.				
	isApplicationReceiptAcknowledgementRequired			Order Header Indicator.Is Application Receipt Acknowledgement Required.Indicator	A buyer's requirement to receive an order receipt acknowledgement from the seller's application system to ensure the seller received the order message.	0..1	Indicator. Content Indicator. Format. Text	[BRAD For Multi Shipment Order Receipt Response and Excise Tax Free V 0.0.4] {BR 1 BR 2}	
	isOrderFreeOfExciseTaxDuty			Order Header Indicator.Is Order Free Of Excise Tax Duty.Indicator	An excise tax is a tax applied to the consumption of a particular type of good, such as alcohol or tobacco. Excise taxes apply at the same rates to domestic or imported goods. They must not be confused with customs duties which apply to imports only.	0..1	Indicator. Content Indicator. Format. Text	[BRAD For Multi Shipment Order Receipt Response and Excise Tax Free V 0.0.4] {BR 1 BR 2}	
	orderInstruction			Order Header Indicator.Order Instruction.SpecialOrderConditionCodeList_Code	Provides special order condition.	0..1	Code. Content	CR 8-40	

3.3.3. Class Diagram: Order Logistical Information

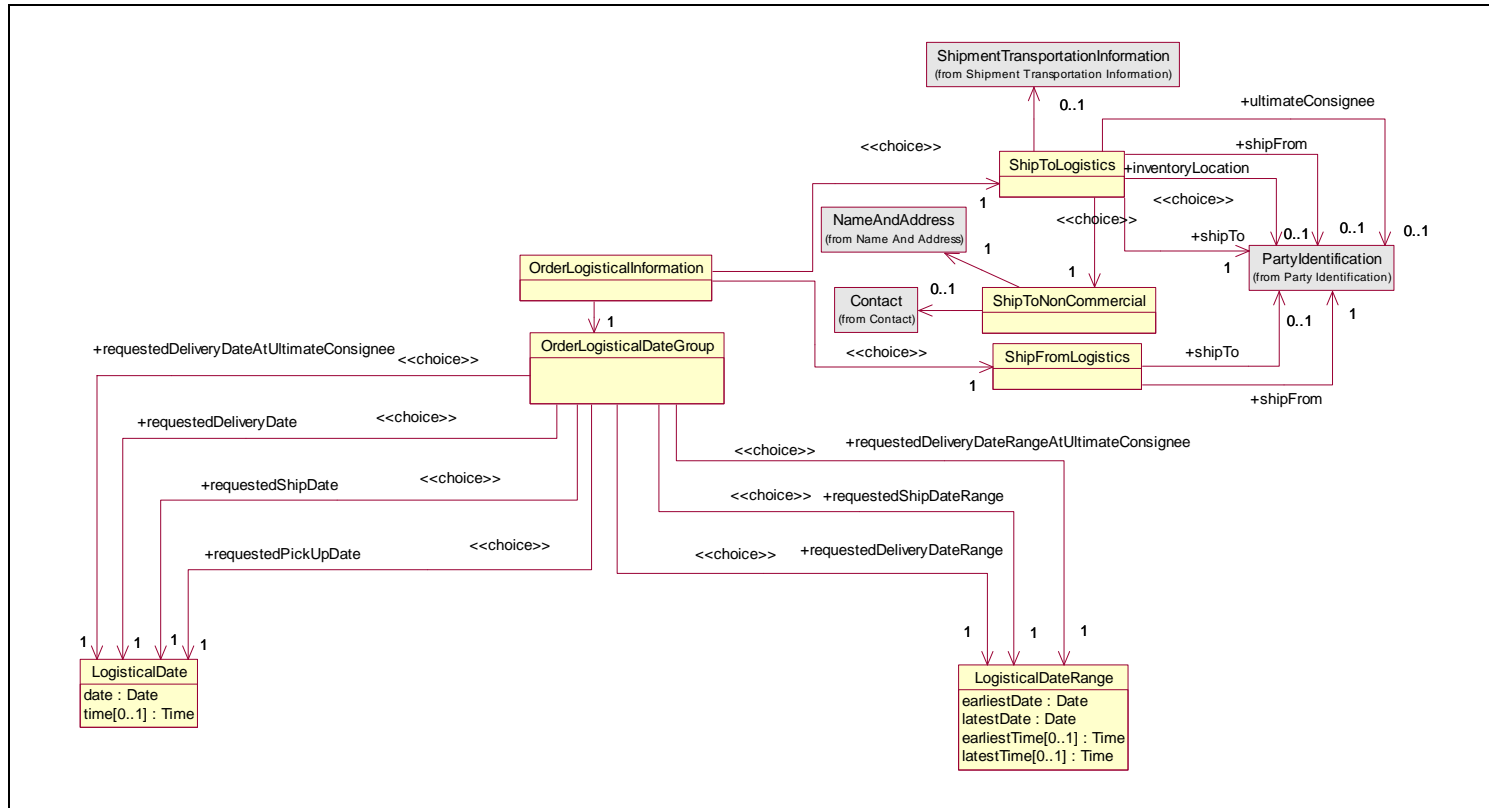

3.3.4. GDD Report: Order Logistical Information

Class (ABIE)	Attribute (BBIE)	Association (ASBIE)	Secondary Class	Official Dictionary Entry Name	Definition	Multi plicity	Data Type Components	Related Requirements	Facets
LogisticalDate				Order Logistical_ Date. Details	Contains the information regarding the specific date and an optional time associated to the logistical information in the order.				
	date			Order Logistical_ Date. Date. Code	The time at which an event occurs, expressed as a day	1..1	Code. Content Code List. Agency. Identifier Code List. Agency Name. Text		Facets constrained by code list values
	time			Order Logistical_ Date. Time. Code	An appointed, fixed, or customary moment or hour for something to happen, begin, or end in a specific role	0..1	Code. Content Code List. Agency. Identifier Code List. Agency Name. Text		Facets constrained by code list values
LogisticalDateRange				Order Logistical_ Time Period. Details	Contains the information regarding the specific date ranges and an optional time ranges associated to the logistical information in the order.				
	earliestDate			Order Logistical_ Time Period. Begin Date. Date_ Date Time	Beginning day for a period	1..1	Date Time. Content		Facets constrained by code list values
	earliestTime			Order Logistical_ Time Period. Begin Time. Code	Beginning time for a period	0..1	Code. Content Code List. Agency. Identifier Code List. Agency Name. Text		Facets constrained by code list values
	latestDate			Order Logistical_ Time Period. End Date. Date_ Date Time	End of a period expressed as a day	1..1	Date Time. Content		Facets constrained by code list values

Class (ABIE)	Attribute (BBIE)	Association (ASBIE)	Secondary Class	Official Dictionary Entry Name	Definition	Multi plicity	Data Type Components	Related Requirements	Facets
	latestTime			Order Logistical_ Time Period. End Time. Code	End of a period expressed as time	0..1	Code. Content Code List. Agency. Identifier Code List. Agency Name. Text		Facets constrained by code list values
OrderLogisticalDateGroup				Order Logistical_ Date Group. Details	Contains the choices to select various types of dates or date ranges associated to the order.				
		requestedDeliveryDate	LogisticalDate	Order Logistical_ Date Group. Choice_Requested Delivery_ Date. Order Logistical_ Date	Provides the date and optional time on which the goods are requested to be delivered.	1..1			
		requestedDeliveryDateAtUltimateConsignee	LogisticalDate	Order Logistical_ Date Group. Choice_Requested Delivery At Ultimate Consignee_ Date. Order Logistical_ Date	Provides the date and optional time on which the goods are requested to be delivered to the Ultimate Consignee.	1..1			
		requestedPickUpDate	LogisticalDate	Order Logistical_ Date Group. Choice_Requested Pick Up_ Date. Order Logistical_ Date	Provides the date and optional time on which the goods are requested to be available for pickup at the seller's location.	1..1			
		requestedShipDate	LogisticalDate	Order Logistical_ Date Group. Choice_Requested Ship_ Date. Order Logistical_ Date	Provides the date and optional time on which the goods are requested to be shipped or dispatched by the supplier.	1..1			
		requestedDeliveryDateRange	LogisticalDateRange	Order Logistical_ Date Group. Choice_Requested Delivery_ Date Range. Order Logistical_ Time Period	Provides the earliest and latest date ranges and the optional times on which the goods are requested to be delivered.	1..1			
		requestedDeliveryDateRangeAtUltimateConsignee	LogisticalDateRange	Order Logistical_ Date Group. Requested Delivery At Ultimate Consignee_ Date Range. Order Logistical_ Time Period	Provides the earliest and latest date ranges and the optional times on which the goods are requested to be delivered to the Ultimate Consignee.	1..1			
		requestedShip	LogisticalDateR	Order Logistical_ Date	Provides the earliest and	1..1			

Class (ABIE)	Attribute (BBIE)	Association (ASBIE)	Secondary Class	Official Dictionary Entry Name	Definition	Multi plicity	Data Type Components	Related Requirements	Facets
		DateRange	ange	Group. Choice_Requested Ship_ Date Range. Order Logistical_ Time Period	latest date ranges and the optional times on which the goods are requested to be shipped or dispatch.				
OrderLogisticalInformation				Order_ Logistical Information Group. Details	Provides the earliest and latest date ranges and the optional times for the range of ship date associated to the order.				
			OrderLogisticalDateGroup	Order_ Logistical Information Group. Association. Order Logistical_ Date Group	Contains the choices to select various types of dates or date ranges associated to the order.	1..1			
			ShipFromLogistics	Order_ Logistical Information Group. Choice_ Association. Ship From_ Party Group	Allows the identification of shipping details where the goods or services must be shipped from.	1..1			
			ShipToLogistics	Order_ Logistical Information Group. Choice_ Association. Ship To_ Party Group	Allows the identification of shipping details where the goods or services must be shipped to.	1..1			
ShipFromLogistics				Ship From_ Party Group. Details	Allows the identification of shipping details where the goods or services must be shipped from.				
		shipFrom	PartyIdentification	Ship From_ Party Group. Ship From. Party Identification	Identifies the origin location where the goods will be shipped.	1..1			
		shipTo	PartyIdentification	Ship From_ Party Group. Ship To. Party Identification	Identifies the destination location where the goods will be shipped.	0..1			
ShipToLogistics				Ship To_ Party Group. Details	Allows the identification of shipping details where the goods or services must be shipped to.				
		inventoryLocation	PartyIdentification	Ship To_ Party Group. Inventory Location. Party Identification	Identifies the location of merchandise or stock on hand.	0..1			
		shipFrom	PartyIdentification	Ship To_ Party Group. Ship From. Party Identification	Identifies the origin location from which goods will be shipped.	0..1			
		shipTo	PartyIdentification	Ship To_ Party Group. Choice_ Ship To. Party	Identifies the destination location to which goods will	1..1			

Class (ABIE)	Attribute (BBIE)	Association (ASBIE)	Secondary Class	Official Dictionary Entry Name	Definition	Multiplicity	Data Type Components	Related Requirements	Facets
				Identification	be shipped.				
		ultimateConsignee	PartyIdentification	Ship To_ Party Group. Ultimate Consignee_ Association. Party Identification	Identifies the final destination location to which goods will be shipped.	0..1			
			ShipmentTransportationInformation	Ship To_ Party Group. Association. Shipment Transportation Information	Contains the trade agreement reference number and the trade agreement reference date.	0..1			
			ShipToNonCommercial	Ship To_ Party Group. Choice Association. Ship To Non Commercial. Details	Contains the identification of the non commercial address and contact information.	1..1		BR3: BRAD Multi Shipment Order Enhancements Version 0.0.1	
ShipToNonCommercial				Ship To Non Commercial. Details	Allows the identification of the ship to non commercial's address and contact information. The destination location to which goods will be shipped when the ship-to party cannot be prealigned due to the business relationship. The Receiver of the items ordered is a non-Retail party that does not have a GLN, for example, ship directly to a consumer.			BR3: BRAD Multi Shipment Order Enhancements Version 0.0.1	
			Contact	Ship To Non Commercial. Details. Association. Contact	The destination contact information to which goods will be shipped when the ship to party cannot be prealigned due to the business relationship. The receiver of the items ordered is a non-Retail party that does not have a GLN, for example, ship directly to a consumer.	0..1		BR3: BRAD Multi Shipment Order Enhancements Version 0.0.1	
			NameAndAddress	Ship To Non Commercial. Details. Association. Party Address Group	The destination location to which goods will be shipped when the ship-to party	1..1		BR3: BRAD Multi Shipment	

Class (ABIE)	Attribute (BBIE)	Association (ASBIE)	Secondary Class	Official Dictionary Entry Name	Definition	Multi plicity	Data Type Components	Related Requirements	Facets
					cannot be prealigned due to the business relationship. The Receiver of the items ordered is a non-Retail party that does not have a GLN, for example, ship directly to a consumer.			Order Enhancements Version 0.0.1	

3.3.5. Class Diagram: Order Party Information

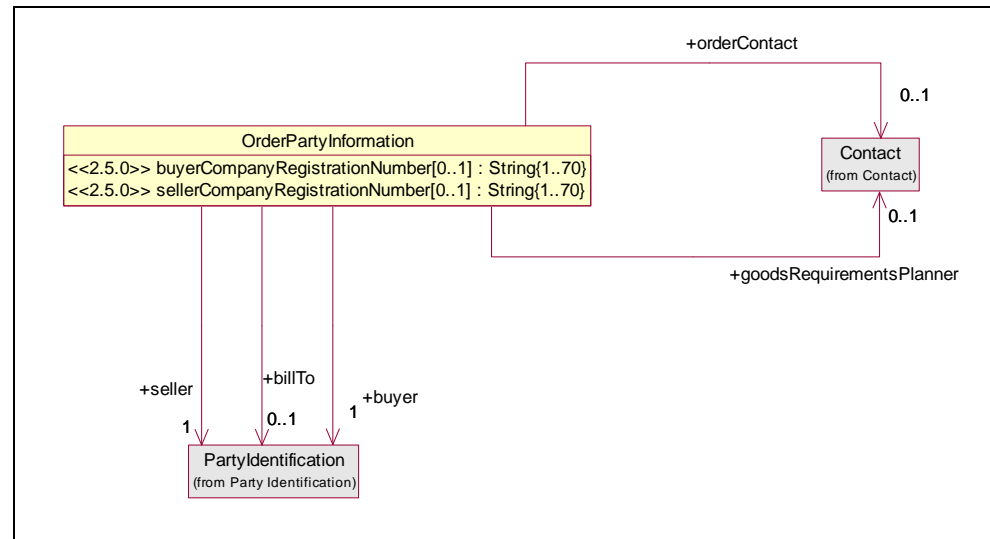

3.3.6. GDD Report: Order Party Information

Class (ABIE)	Attribute (BBIE)	Association (ASBIE)	Secondary Class	Official Dictionary Entry Name	Definition	Multi plicity	Data Type Components	Related Requirements	Face ts
OrderPartyInf or mation				Order_ Party Group. Details	Contains the information regarding the parties related in the order process.				
	buyerCompany RegistrationNu			Order_ Party Group.Buyer	The Company Registration Number is a single identifier for all business	0..1	Text. Content	CR 8-55	min

Class (ABIE)	Attribute (BBIE)	Association (ASBIE)	Secondary Class	Official Dictionary Entry Name	Definition	Multi plicity	Data Type Components	Related Requirements	Face ts
	mber			Company Registration Number.Text	dealings with the tax office and for dealings with other government departments and agencies. This specifies the buyer company registration number.				Length='1' max Length='70'
	sellerCompany RegistrationNumber			Order_ Party Group.Seller Company Registration Number.Text	The Company Registration Number is a single identifier for all business dealings with the tax office and for dealings with other government departments and agencies. This specifies the seller company registration number.	0..1	Text. Content	CR 8-55	min Length='1' max Length='70'
		goodsRequirementsPlanner	Contact	Order_ Party Group. Goods Requirements Planner_ Association. Contact	Contains the contact information of the person or department responsible for the planning at the buyer side.	0..1			
		orderContact	Contact	Order_ Party Group. Order Contact_ Association. Contact	Department or person responsible for issuing the order.	0..1			
		billTo	PartyIdentification	Order_ Party Group. Bill To. Party Identification	Identifies the party which receives invoice.	0..1			
		buyer	PartyIdentification	Order_ Party Group. Buyer. Party Identification	Identifies the party to which products or services is sold.	1..1			
		seller	PartyIdentification	Order_ Party Group. Seller. Party Identification	Identifies the party which sells products or services to a buyer.	1..1			

3.3.7. Class Diagram: Simple Order Line Item

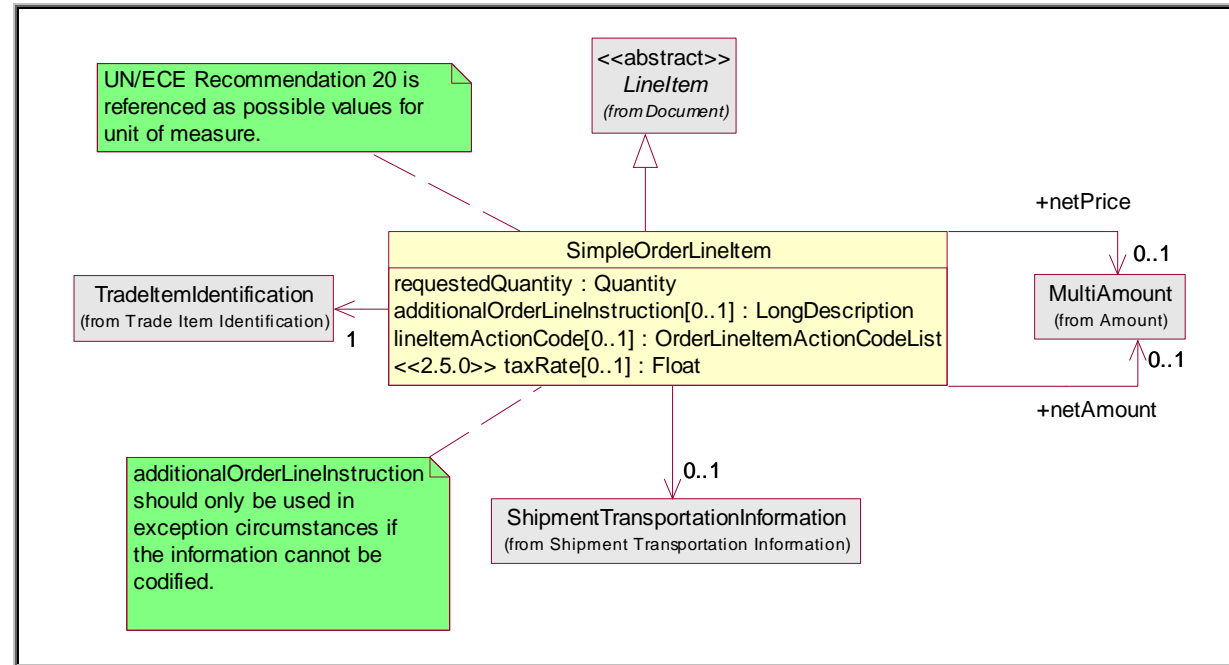

3.3.8. GDD Report: Simple Order Line Item

Class (ABIE)	Attribute (BBIE)	Association (ASBIE)	Secondary Class	Official Dictionary Entry Name	Definition	Multiplicity	Data Type Components	Related Requirements	Facets
SimpleOrderLineItem				Simple_Purchase Order Line. Details	Specify the information related to each line item within the order.				
	additionalOrderLineInstruction			Simple_Purchase Order Line.Additional Order Line Instruction.{1..1000}_Text	Additional Order Line Instruction captures information that has not been previously synchronised and is ad-hoc in nature. This field should only be used in exception circumstances if the information cannot be codified. Examples of Purchase Order Line: Use chrome hinges (not standard brass hinges) Please use timber Please prime (paint) door and jamb and pre-hang door	0..1	Language. Identifier Text. Content	BR2: BRAD Multi Shipment Order Enhancements Version 0.0.1	
	lineItemActionCode			Simple_Purchase Order Line.Line	Provides the activity required by the recipient on the line item of this order line	0..1	Code. Content	BR1: BRAD	Facets Constrain

Class (ABIE)	Attribute (BBIE)	Association (ASBIE)	Secondary Class	Official Dictionary Entry Name	Definition	Multiplicity	Data Type Components	Related Requirements	Facets
				Item Action Code. Order Line Item Action Code List_ Code	item.			Multi Shipment Order Line Item Version 0.0.1	ed by Code List Values
	requestedQuantity			Simple_ Purchase Order Line. Requested_ Quantity. Quantity	The quantity which has been requested.	1..1	Text. Content		Unbounded
	taxRate			Simple_ Purchase Order Line. Tax Rate. Float_ Numeric	This tax rate is known as GST (Goods and Services Tax) and is a value added tax applying to the majority of goods and services sold in Australia.	0..1	Numeric. Content	CR8-5	
				Simple_ Purchase Order Line. Association. Shipment Transportation Information	Contains the identification of the carrier and mode associated with the transportation of the goods or services	0..1			
			LineItem	Simple_ Purchase Order Line. Inheritance_ Association. Line Item	Provides the line number associated to the Simple Order Line Item.	1..1			
		netAmount	MultiAmount	Simple_ Purchase Order Line. Net Amount. Multi-currency Amount	Identifies the net amount of the item.	0..1			
		netPrice	MultiAmount	Simple_ Purchase Order Line. Net_ Price. Multi-currency Amount	Identifies the net price of the item.	0..1			
			ShipmentTransportationInformation	Simple_ Purchase Order Line. Association. Shipment Transportation Information	Provides the shipment transportation information details.	0..1			
			TradeItemIdentification	Simple_ Purchase Order Line. Association. Trade Item Identification	Identifies the Trade Item with the Global Trade Item Number associated to the Simple Order Line Item.	1..1			

3.3.9. Class Diagram: Shipment Detail

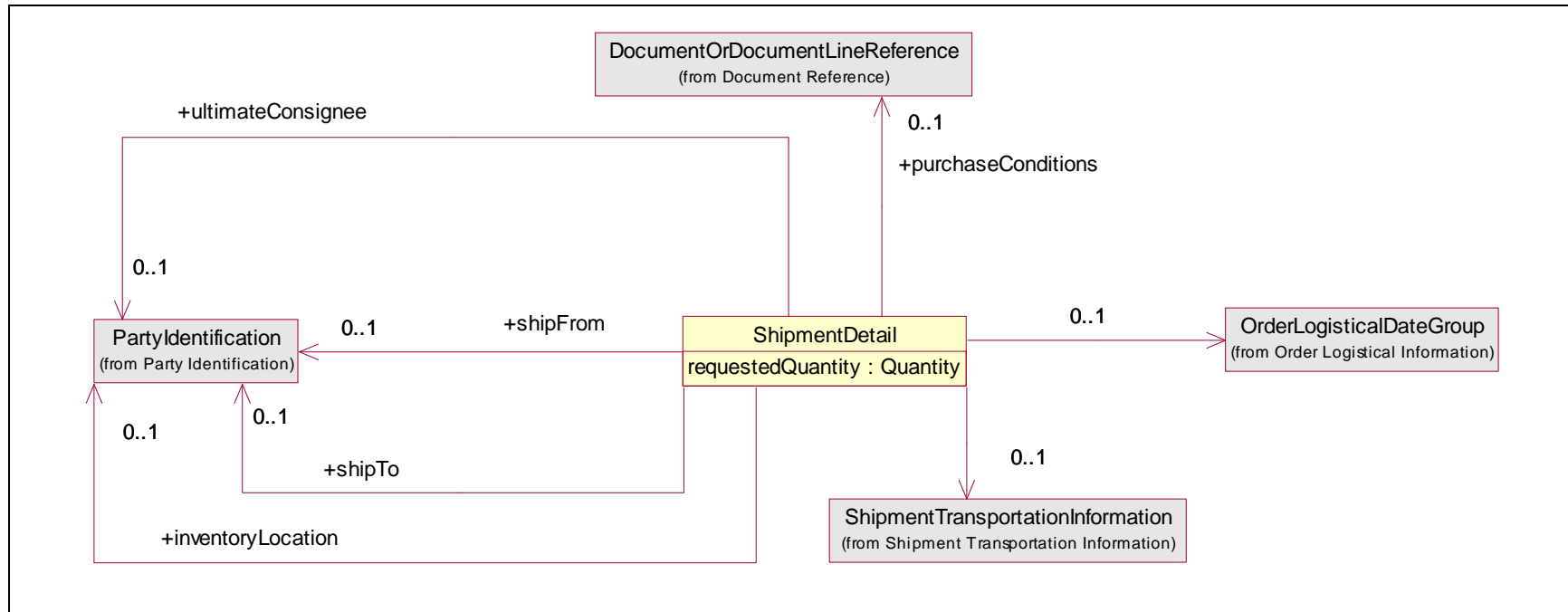

3.3.10. GDD Report: Shipment Detail

Class (ABIE)	Attribute (BBIE)	Association (ASBIE)	Secondary Class	Official Dictionary Entry Name	Definition	Multiplicity	Data Type Components	Related Requirements	Facets
Shipment Detail				Multi Shipment_ Purchase Order Sub Line. Details	Allows the identification of various shipping details by MultiShipmentOrderLineItem.				

	requestedQuantity			Multi Shipment_ Purchase Order Sub Line. Requested Quantity_ Quantity. Quantity	The quantity which has been requested.	1..1	Quantity. Content Quantity Unit. Code Quantity Unit. Code List Agency. Identifier		No Restrictions
		purchaseConditions	DocumentOrDocumentLineReference	Multi Shipment_ Purchase Order Sub Line. Purchase Conditions_ Association. Document Or Document Line Reference	A reference to the purchase conditions. The reference is associated with specific items in the order.	0..1			
			OrderLogisticalDateGroup	Multi Shipment_ Purchase Order Sub Line. Association. Order Logistical_ Date Group	The date/time on which the goods are requested, to be delivered, pickup or shipped.	0..1			
		inventoryLocation	PartyIdentification	Multi Shipment_ Purchase Order Sub Line. Inventory Location_ Association. Party Identification	The location where the goods are stored.	0..1			
		shipFrom	PartyIdentification	Multi Shipment_ Purchase Order Sub Line. Ship From_ Association. Party Identification	The location from which goods will be shipped.	0..1			
		shipTo	PartyIdentification	Multi Shipment_ Purchase Order Sub Line. Ship To_ Association. Party Identification	The location destination to which goods will be shipped.	0..1			
		ultimateConsignee	PartyIdentification	Multi Shipment_ Purchase Order Sub Line. Ultimate Consignee_ Association. Party Identification	The final destination to which goods will be shipped.	0..1			
			ShipmentTransportationInformation	Multi Shipment_ Purchase Order Sub Line. Association. Shipment Transportation Information	Contains the identification of the carrier and mode associated with the transportation of the goods or services.	0..1			

3.3.11. Class Diagram: Trade Agreement

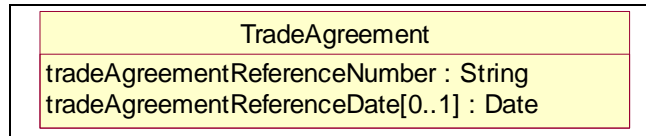

3.3.12. GDD Report: Trade Agreement

Class (ABIE)	Attribute (BBIE)	Association (ASBIE)	Secondary Class	Official Dictionary Entry Name	Definition	Multiplicity	Data Type Components	Related Requirements	Facets
TradeAgreement				Trade Agreement. Details	Contains the trade agreement reference number and the trade agreement reference date.				
	tradeAgreementReferenceDate			Trade Agreement.Trade Agreement Reference Date.Date_ Date Time	Unique date identifying a trade agreement that the order is referring to.	0..1	Date Time. Content		No restrictions
	tradeAgreementReferenceNumber			Trade Agreement. Number_ Reference. Text	Unique number identifying a trade agreement that the order is referring to. A number of different trading agreements may exist.	1..1	Text. Content		Unbounded

3.4. Package Overview: Pay Common

3.4.1. Class Diagram: Financial Institution Information

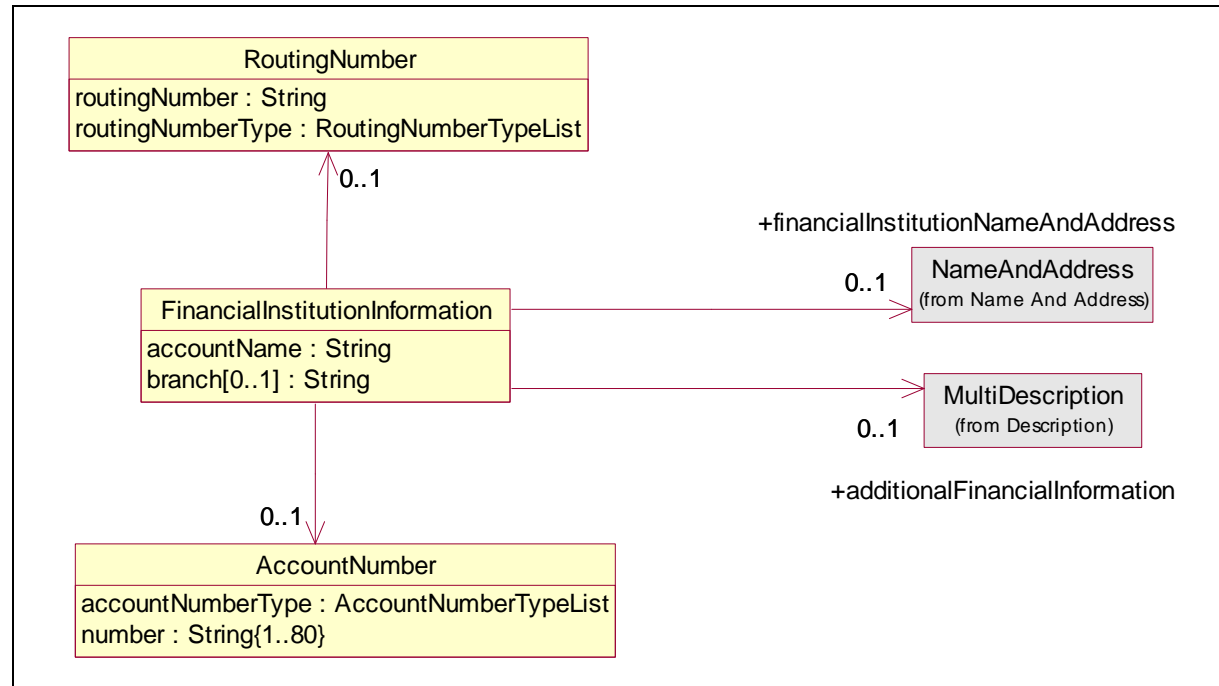

3.4.2. GDD Report: Financial Institution Information

Class (ABIE)	Attribute (BBIE)	Association (ASBIE)	Secondary Class	Official Dictionary Entry Name	Definition	Multiplicity	Data Type Components	Related Requirements	Facets
AccountNumber				Financial_ Account. Details	This identifies the account number.				
	number			Financial_ Account. Account Number.Text	The identification of the account run by a financial institution.	1..1	Text. Content		minLength='1' maxLength='80'
	accountNumber			Financial_ Account.	This will identify the type of the	1..1	Numeric.		No

Class (ABIE)	Attribute (BBIE)	Association (ASBIE)	Secondary Class	Official Dictionary Entry Name	Definition	Multiplicity	Data Type Components	Related Requirements	Facets
	rType			Account Number Type. Account Number Type_ Code	account number.		Content Numeric. Format. Text		Restrictions
FinancialInstitutionInformation				Financial Institution. Details	Information that is used for identifying the Financial Institution that will process the information.				
	accountName			Financial Institution. Account_ Name. Text	Name of account owner of originating transaction.	1..1	Text. Content		minLength='1' maxLength='80'
	branch			Financial Institution. Branch_ Name. Text	Identification for a division, location of the account holder's financial institution	0..1	Text. Content		minLength='1' maxLength='80'
			AccountNumber	Financial Institution. Association. Financial_ Account	Provides the Account Number for the Financial Institution.	0..1			
		additionalFinancialInformation	MultiDescription	Financial Institution. Description. Multi-language Description	A description used to provide any additional information about a financial institution.	0..1			
		financialInstitutionNameAndAddress	NameAndAddress	Financial Institution. Association. Party Address Group	The company name and address of a financial institution.	0..1			
			RoutingNumber	Financial Institution. Association. Financial_ Routing	Provides the Routing Number for the Financial Institution.	0..1			
RoutingNumber				Financial_ Routing. Details	Provides the routing information regarding the routing number and routing number type.				
	routingNumber			Financial_ Routing. Number. Text	Number assigned to a transaction in financial routing between parties. The number is determined by and used in conjunction with the type of routing, e.g. SWIFT,ABA,CHIPS.	1..1	Text. Content		Facets constrained by code list values

Class (ABIE)	Attribute (BBIE)	Association (ASBIE)	Secondary Class	Official Dictionary Entry Name	Definition	Multiplicity	Data Type Components	Related Requirements	Facets
	routingNumberType			Financial_ Routing. Routing Number Type. Code	A predefined selection of code names used to identify the type of routing number used in the message. Also see Routing Number List.	1..1	Code. Content Code List. Agency. Identifier Code List. Agency Name. Text		Facets constrained by code list values

3.4.3. Class Diagram: Invoice Allowance Charge

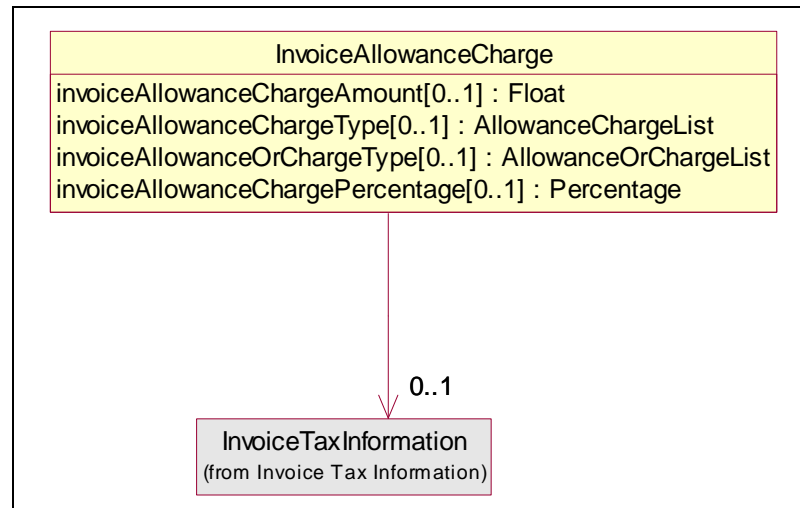

3.4.4. GDD Report: Invoice Allowance Charge

Class (ABIE)	Attribute (BBIE)	Association (ASBIE)	Secondary Class	Official Dictionary Entry Name	Definition	Multiplicity	Data Type Components	Related Requirements	Facets
InvoiceAllowance Charge				Invoice Allowance Charge. Details	The allowances and/or charges applicable to the invoice.				
	invoiceAllowanceChargeAmount			Invoice Allowance Charge. Invoice Allowance Charge	Amount of allowance or charge applicable to the complete invoice.	0..1	Code. Content Code List. Agency. Identifier		No restrictions Facets

				Amount. Amount			Code List. Agency Name. Text		constrained by code list values
	invoiceAllowanceChargePercentage			Invoice Allowance Charge. Invoice Allowance Charge Percentage. Percent _ Numeric	Percentage of allowance and/or charge applied at Invoice header or line level (for information only)	0..1	Numeric. Content	CR 08-127, CR 09-134	Percentage
	invoiceAllowanceChargeType			Invoice Allowance Charge. Invoice Allowance Charge Type. Code	Code specifying the identification of an allowance or charge.	0..1	Code. Content Code List. Agency. Identifier Code List. Agency Name. Text		Facets constrained by code list values
	invoiceAllowanceOrChargeType			Invoice Allowance Charge. Invoice Allowance Or Charge Type. Code	Code specifying whether the amount is a deduction (allowance) or addition (charge) to the invoiced amount.	0..1	Code. Content Code List. Agency. Identifier Code List. Agency Name. Text		Facets constrained by code list values
			InvoiceTaxInformation	Invoice Allowance Charge. Association. Invoice Tax Information	Information about the tax applicable to the allowance and/or charge.	0..1			

3.4.5. Class Diagram: Invoice Party

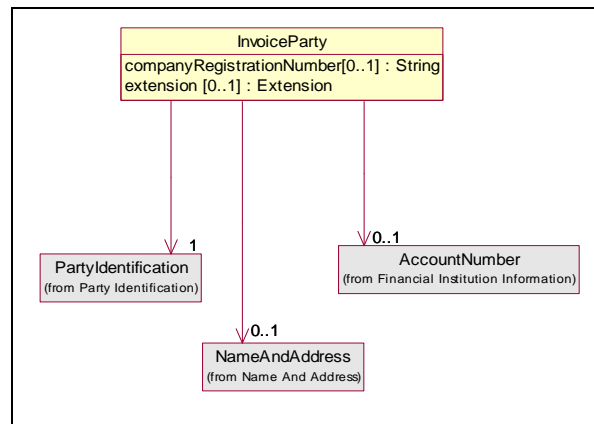

3.4.6. GDD Report: Invoice Party

Class (ABIE)	Attribute (BBIE)	Association (ASBIE)	Secondary Class	Official Dictionary Entry Name	Definition	Multiplicity	Data Type Components	Related Requirements	Facets
InvoiceParty				Invoice Party. Details	Provides the unique identifier, name and address, and the account number information.				
	companyRegistrationNumber			Invoice Party. Company Registration Number. Text	Company registration number as legally required.	0..1	Text. Content		Unbounded
	extension			Invoice Party. Extension. Extension_ Text	Extension point	0..1	Text. Content		Unbounded
			AccountNumber	Invoice Party. Association. Financial_ Account	Identification assigned by the account servicing bank to identify the account of the account owner.	0..1			
			NameAndAddress	Invoice Party. Association. Party Address Group	The specification of person and a physical location.	0..1			
			PartyIdentification	Invoice Party. Association. Party Identification	The identification of a party.	1..1			

3.4.7. Class Diagram: Invoice Tax Information

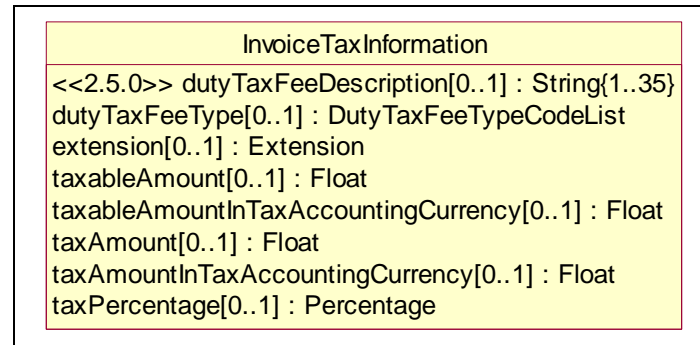

3.4.8. GDD Report: Invoice Tax Information

Class (ABIE)	Attribute (BBIE)	Association (ASBIE)	Secondary Class	Official Dictionary Entry Name	Definition	Multiplicity	Data Type Components	Related Requirements	Facets
InvoiceTaxInformation				Invoice Tax Information. Details	Information about the taxes applicable to the invoice.				
	dutyTaxFeeDescription			Invoice Tax Information. Duty Tax Fee Description. Text	Automatically generated text description of tax type code. For example, "Taxes sur les supports audio". WEEE is for Waste Electrical and Electronic Equipment"	0..1	Text. Content	CR 8-209	minLength='1' maxLength='35'
	dutyTaxFeeType			Invoice Tax Information. Duty Tax Fee Type. Code	Type of duty, tax or fee.	0..1	Code. Content Code List. Agency. Identifier Code List. Agency Name. Text	[BRAD Upstream Standards –Financial Settlement 0.1.0] {7.1.1-70}	Facets constrained by code list values
	extension			Invoice Tax Information. Extension. Extension_ Text	Extension Point	0..1	Text. Content	[BRAD Upstream Standards –Financial Settlement 0.1.0] {7.1.1-70}	Unbounded
	taxableAmount			Invoice Tax Information. Taxable Amount. Float_ Numeric	Amount on which a tax has to be applied.	0..1	Numeric. Content	[BRAD Upstream Standards –Financial Settlement 0.1.0] {7.1.1-70}	No Restrictions

Class (ABIE)	Attribute (BBIE)	Association (ASBIE)	Secondary Class	Official Dictionary Entry Name	Definition	Multiplicity	Data Type Components	Related Requirements	Facets
	taxableAmountInTaxAccountingCurrency			Invoice Tax Information. Taxable Amount In Tax_ Accounting Currency. Float_ Numeric	Amount on which a tax has been applied, where the monetary value is expressed in the currency used for tax accounting purposes.	0..1	Numeric. Content	[BRAD Upstream Standards –Financial Settlement 0.1.0] {7.1.1-81}	No Restrictions
	taxAmount			Invoice Tax Information. Tax Amount. Float_ Numeric	Tax imposed by government or other official authority related to the weight/volume charge or valuation charge.	0..1	Numeric. Content	[BRAD Upstream Standards –Financial Settlement 0.1.0] {7.1.1-78}	No Restrictions
	taxAmountInTaxAccountingCurrency			Invoice Tax Information. Tax Amount In Tax_ Accounting Currency. Float_ Numeric	Tax imposed by government or other official authority related to the weight/volume charge or valuation charge, and where the monetary value is expressed in the currency used for tax accounting purposes.	0..1	Numeric. Content	[BRAD Upstream Standards –Financial Settlement 0.1.0] {7.1.1-82}	No Restrictions
	taxPercentage			Invoice Tax Information. Tax Percentage. Percent_ Numeric	Tax Percentage is defined as a percentage or rate on the line item.	0..1	Numeric. Content	[BRAD Invoice Enhancement V 0.0.1] {BR# 3}	Percentage

3.4.9. Class Diagram: Payment Method

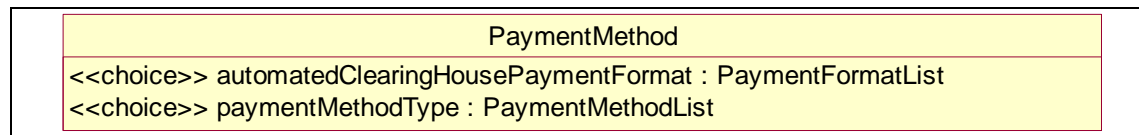

3.4.10. GDD Report: Payment Method

Class (ABIE)	Attribute (BBIE)	Association (ASBIE)	Secondary Class	Official Dictionary Entry Name	Definition	Multiplicity	Data Type Components	Related Requirements	Facets
PaymentMethod				Pay_ Payment Method. Details	Provides the choice of payment method.				
	automatedClearingHousePaymentFormat			Pay_ Payment Method. Choice_ Automated Clearing	A predefined list of values that identify the format used when payment is made	1..1	Code. Content Code List. Agency.		Facets constrained by code list values

Class (ABIE)	Attribute (BBIE)	Association (ASBIE)	Secondary Class	Official Dictionary Entry Name	Definition	Multiplicity	Data Type Components	Related Requirements	Facets
				House_ Format. Code	through an automated clearing house.		Identifier Code List. Agency Name. Text		
	paymentMethodType			Pay_ Payment Method. Choice_ Payment Method. Code	A predefined list that identifies a method of payment. Also see Payment Method List.	1..1	Code. Content Code List. Agency. Identifier Code List. Agency Name. Text		Facets constrained by code list values

3.5. Package Overview: Process Common

3.5.1. Class Diagram: Contact

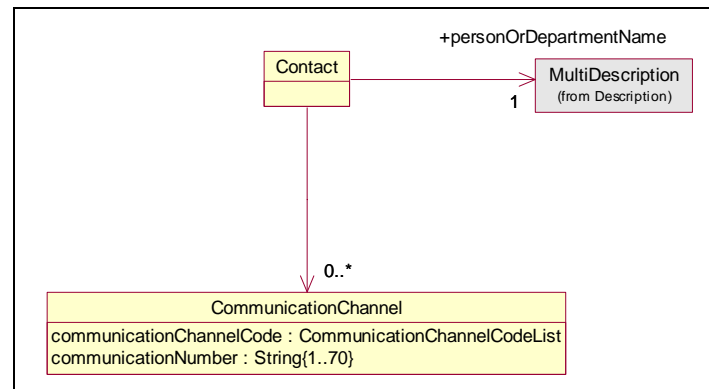

3.5.2. GDD Report: Contact

Class (ABIE)	Attribute (BBIE)	Association (ASBIE)	Secondary Class	Official Dictionary Entry Name	Definition	Multiplicity	Data Type Components	Related Requirements	Facets
CommunicationChannel				Communication Channel. Details	The channel or manner in which a communication can be made, such as telephone or email.				
	communication			Communication	Means used to communicate	1..1	Text.		Unbounded

Class (ABIE)	Attribute (BBIE)	Association (ASBIE)	Secondary Class	Official Dictionary Entry Name	Definition	Multiplicity	Data Type Components	Related Requirements	Facets
	tionChannelCode			Channel. Communication Channel. Text	with another party.		Content		
	communicationNumber			Communication Channel. Communication Number. Text	Number assigned to a specific means of communication.	1..1	Text. Content		minLength='1' maxLength='70'
Contact				Contact. Details	The name and associated communication channel of a given party or organisation.				
			Communication Channel	Contact. Association. Communication Channel	This information on CommunicationChannel for Contact.	0..*			
		personOrDepartmentName	MultiDescription	Contact. Person or Department_ Name. Multi-language Description	The name of a department within this address. The name of the individual or department that can be contacted to provide additional information.	1..1			

3.5.3. Class Diagram: Currency Exchange Rate Information

CurrencyExchangeRateInformation
currencyConversionFrom : ISO4217_Code
currencyConversionTo : ISO4217_Code
exchangeRate : Float
exchangeRateDate [0..1] : Date

3.5.4. GDD Report: Currency Exchange Rate Information

Class (ABIE)	Attribute (BBIE)	Association (ASBIE)	Secondary Class	Official Dictionary Entry Name	Definition	Multiplicity	Data Type Components	Related Requirements	Facets
CurrencyExchangeRateInformation				Currency Exchange Rate Information. Details	Provides the currency exchange rate information. Rate at which one currency may be converted into another. Generally, one unit of the home currency is				

Class (ABIE)	Attribute (BBIE)	Association (ASBIE)	Secondary Class	Official Dictionary Entry Name	Definition	Multi plicity	Data Type Components	Related Requirements	Facets
					expressed in terms of another currency. For example, a North American bank may quote the exchange rate between the dollar and the Euro as the number of dollars needed to buy one Euro.				
	currencyConversionFrom			Currency Exchange Rate Information. Currency Conversion From_ ISO4217 Code. ISO_ Currency_ Code	ISO Code for the currency from which an amount is converted	1..1	Code. Content		Facets constrained by code list values
	currencyConversionTo			Currency Exchange Rate Information. Currency Conversion To_ ISO4217 Code. ISO_ Currency_ Code	ISO Code for the currency to which an amount is converted	1..1	Code. Content		Facets constrained by code list values
	exchangeRate			Currency Exchange Rate Information. Exchange Rate_ Float. Float_ Numeric	The price of one currency in terms of another, that is, the number of units of one currency that may be exchanged for one unit of another currency.	1..1	Numeric. Content		No Restrictions
	exchangeRateDate			Currency Exchange Rate Information. Exchange Rate Date. Date_ Date Time	The date as of which the currency exchange rate is valid.	0..1	Date Time. Content		No restrictions

3.5.5. Class Diagram: Name and Address

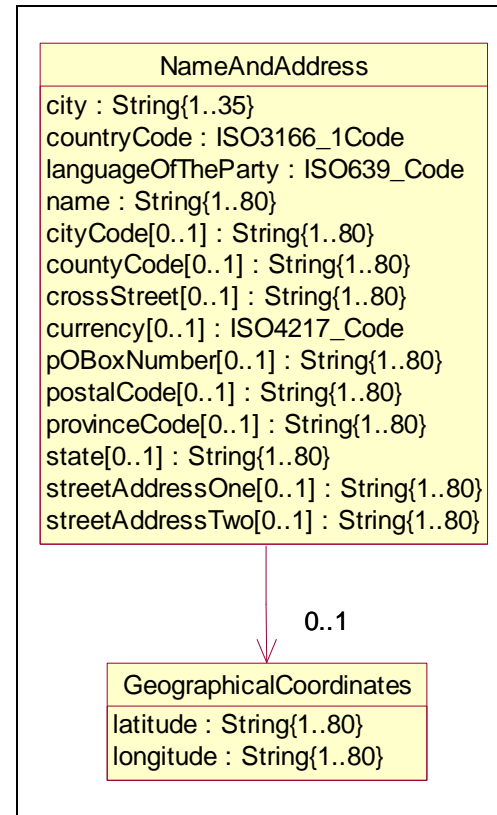

3.5.6. GDD Report: Name and Address

Class (ABIE)	Attribute (BBIE)	Association (ASBIE)	Secondary Class	Official Dictionary Entry Name	Definition	Multiplicity	Data Type Components	Related Requirements	Facets
Geographical Coordinates				Geographical Coordinate. Details	The longitude and latitude of a geographical location.				
	latitude			Geographical Coordinate. Latitude. Text	Angular distance North or South from the earths equator measured through 90 degrees.	1..1	Text. Content		minLengt h='1' maxLengt h='80'

Class (ABIE)	Attribute (BBIE)	Association (ASBIE)	Secondary Class	Official Dictionary Entry Name	Definition	Multiplicity	Data Type Components	Related Requirements	Facets
	longitude			Geographical Coordinate. Longitude. Text	The arc or portion of the earths equator intersected between the meridian of a given place and the prime meridian and expressed either in degrees or in time	1..1	Text. Content		minLength='1' maxLength='80'
NameAndAddress				Party Address Group. Details	Each party will identify their party name and address. The Party information includes city, name, country code ISO 3166, and the language of the party ISO 639-1988. Optional address information may include: street address, P.O. Box number, state, province code, postal code, latitude, longitude, cross street, county code, city code.				
	city			Party Address Group. City. Text	An inhabited place of greater size, population, or importance than a town or village where the initial ship to location took place	1..1	Text. Content		minLength='1' maxLength='35'
	cityCode			Party Address Group. City Code. Text	Identifier for a city, expressed as a short code rather than the full name	0..1	Text. Content		minLength='1' maxLength='80'
	countryCode			Party Address Group. Country Code. Text	ISO 3661-1 Country Code associated with consignee address	1..1	Text. Content		Unbounded
	countyCode			Party Address Group. County Code. Text	A code that identifies a county. A county is a territorial division in some countries, forming the chief unit of local administration. In the US, a county is a political and administrative division of a state.	0..1	Text. Content		minLength='1' maxLength='80'
	crossStreet			Party Address Group. Cross Street. Text	A street intersecting a main street (usually at right angles) and continuing on both sides of it	0..1	Text. Content		minLength='1' maxLength='80'

Class (ABIE)	Attribute (BBIE)	Association (ASBIE)	Secondary Class	Official Dictionary Entry Name	Definition	Multiplicity	Data Type Components	Related Requirements	Facets
	currency			Party Address Group. Currency. Text	The ISO currency code of the currency in which business is conducted with the current party (i.e. currency in which orders are placed and invoices are paid).	0..1	Text. Content		Unbounded
	languageOfTheParty			Party Address Group. Language. Text	The ISO code of the language in which business with the current party is conducted.	1..1	Text. Content		Unbounded
	name			Party Address Group. Name. Text	The name of the party expressed in text.	1..1	Text. Content		minLength='1' maxLength='80'
	pOBoxNumber			Party Address Group. PO Box Number. Text	The number that identifies a PO box. A PO box is a box in a post office or other postal service location assigned to an organization where postal items may be kept.	0..1	Text. Content		minLength='1' maxLength='80'
	postalCode			Party Address Group. Postal Code. Text	Code defining international postal zone code.	0..1	Text. Content		minLength='1' maxLength='80'
	provinceCode			Party Address Group. Province Code. Text	Free form text for State/Province.	0..1	Text. Content		minLength='1' maxLength='80'
	state			Party Address Group. State. Text	One of the constituent units of a nation having a federal government.	0..1	Text. Content		minLength='1' maxLength='80'
	streetAddressOne			Party Address Group. Street Address One. Text	The first free form line of an address, This first part is printed on paper as the first line below the name. For example, the name of the street and the number in the street or the name of a	0..1	Text. Content		minLength='1' maxLength='80'

Class (ABIE)	Attribute (BBIE)	Association (ASBIE)	Secondary Class	Official Dictionary Entry Name	Definition	Multiplicity	Data Type Components	Related Requirements	Facets
					building.				
	streetAddressTwo			Party Address Group. Street Address Two. Text	The second free form line of an address, This second part is printed on paper as the second line below the name. The second free form line complements the first free form line to locate the party e.g. floor number, name of a building, suite number o	0..1	Text. Content		minLength='1' maxLength='80'
			Geographical Coordinates	Party Address Group. Association. Geographical Coordinate	This information on GeographicalCoordinates for NameAndAddress.	0..1			

3.5.7. Class Diagram: Shipment Transportation Information

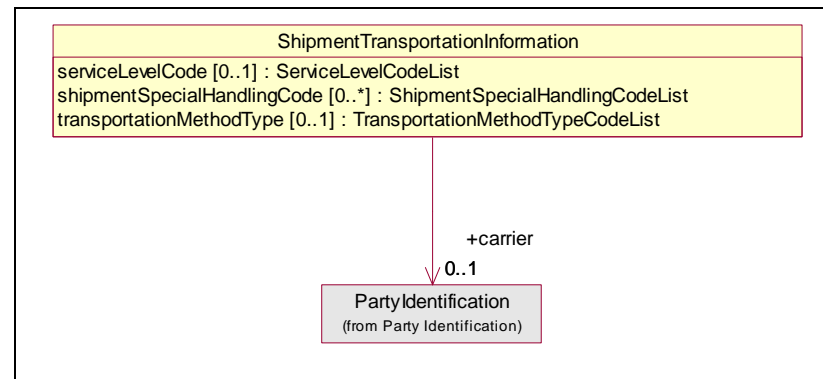

3.5.8. GDD Report: Shipment Transportation Information

Class (ABIE)	Attribute (BBIE)	Association (ASBIE)	Secondary Class	Official Dictionary Entry Name	Definition	Multiplicity	Data Type Components	Related Requirements	Facets
ShipmentTransportationI				Shipment Transportation	When shipments from the Supplier to a Buyer or other				

Class (ABIE)	Attribute (BBIE)	Association (ASBIE)	Secondary Class	Official Dictionary Entry Name	Definition	Multiplicity	Data Type Components	Related Requirements	Facets
Information				Information. Details	non-Retail party are made, the Buyer may stipulate the method of shipment and/or the carrier to be used for the shipment.				
	serviceLevelCode			Shipment Transportation Informaiton. Code. Service Level_ Code	Allows to specify the service level of shipment - in addition to designating the transportation method.	0..1	Code. Content		Facets constrained by code list values
	shipmentSpecialHandlingCode			Shipment Transportation Information.Shipment Special Handling Code.Shipment Special Handling_ Code	Provides the special handling requirements for a specific shipment.	0..*	Code. Content		Facets constrained by code list values
	transportationMethodType			Shipment Transportation Informaiton. Method Type. Transportation Method Type Code List_ Code	The shipment designation. Examples: FedEx, UPS, air, ground, etc.	0..1	Code. Content		Facets constrained by code list values
		carrier	PartyIdentification	Shipment Transportation Information. Carrier. Party Identification	Allows to specify the carrier to be used for the shipment.	0..1			

3.6. Package Overview: Terms

3.6.1. Class Diagram: Allowance Charge

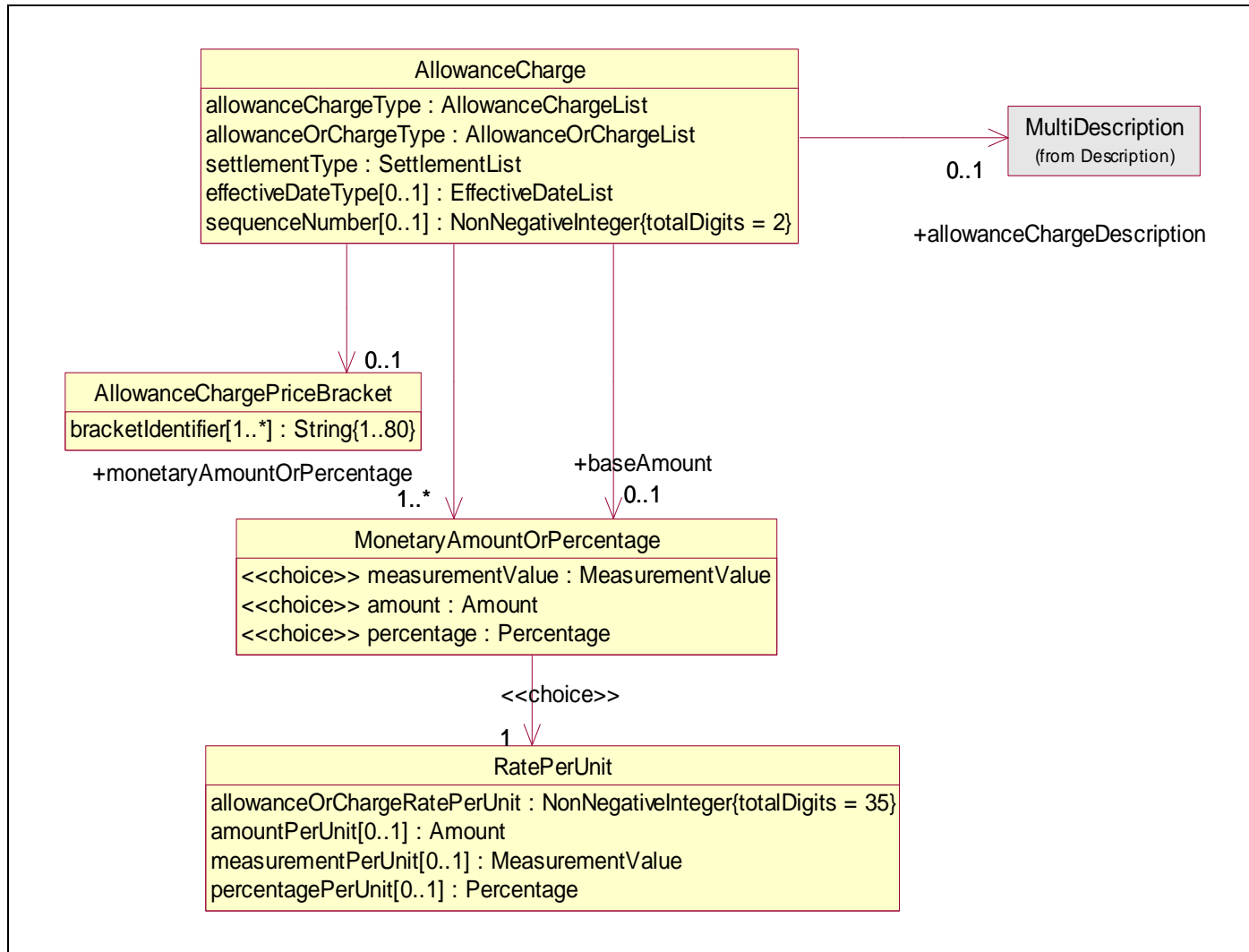

3.6.2. GDD Report: Allowance Charge

Class (ABIE)	Attribute (BBIE)	Association (ASBIE)	Secondary Class	Official Dictionary Entry Name	Definition	Multiplicity	Data Type Components	Related Requirements	Facets
AllowanceCharge				Allowance Charge. Details	Specifies allowances and charges specified to either the entire message or to individual line items contained in the message.				
	allowanceChargeType			Allowance Charge. Allowance Charge_Type. Indicator	The identification of an allowance charge selected from a predefined list. Also see Allowance Charge List.	1..1	Indicator. Content Indicator. Format. Text		No Restrictions
	allowanceOrChargeType			Allowance Charge. Allowance Or Charge_Type. Indicator	The identification of either an allowance or a charge selected from the allowance or charge list.	1..1	Indicator. Content Indicator. Format. Text		No Restrictions
	effectiveDateType			Allowance Charge. Effective_Date Type. Indicator	The date on which this event is effective	0..1	Indicator. Content Indicator. Format. Text		No Restrictions
	sequenceNumber			Allowance Charge. Sequence Number. Integer_Numeric	A unique number used to indicate the order in which the allowances or charges are to be calculated.	0..1	Numeric. Content		totalDigits='2'
	settlementType			Allowance Charge. Settlement_Type. Indicator	The identification of a type of settlement selected from a predetermined list of types. Also see Allowance Charge List.	1..1	Indicator. Content Indicator. Format. Text		No Restrictions
			Allowance ChargePriceBracket	Allowance Charge. Association. Allowance Charge_Price Bracket	This information on AllowanceChargePriceBracket for AllowanceCharge.	0..1			
			Monetary AmountOrPercentage	Allowance Charge. Monetary Amount Or Percentage. Amount Percent Group	The amount of the allowance charge expressed as a measurement value, amount or percent.	1..*			

Class (ABIE)	Attribute (BBIE)	Association (ASBIE)	Secondary Class	Official Dictionary Entry Name	Definition	Multiplicity	Data Type Components	Related Requirements	Facets
		baseAmount	Monetary AmountOrPercentage	Allowance Charge. Base Amount. Amount Percent Group	The amount of the allowance charge expressed as a measurement value, amount or percent.	0..1			
		allowanceChargeDescription	MultiDescription	Allowance Charge. Allowance Charge_ Description. Multi-language Description	A text explanation of the allowance or charge. description is optional	0..1			
AllowanceChargePriceBracket				Allowance Charge_ Price Bracket. Details					
	bracketIdentifier			Allowance Charge_ Price Bracket. Description. Text	A code that identifies a price bracket.	1..*	Text. Content		minLength='1' maxLength='80'
MonetaryAmountOrPercentage				Amount Percent Group. Details					
	amount			Amount Percent Group. Choice_ Amount. Numeric	used to indicate an allowance or charge applied against a given other amount	1..1	Numeric. Content Numeric. Format. Text		No Restrictions
	measurementValue			Amount Percent Group. Choice_ Measurement. Numeric	used to indicate an allowance or charge applied against a given measurement or quantity	1..1	Numeric. Content Numeric. Format. Text		No Restrictions
	percentage			Amount Percent Group. Choice_ Percentage. Numeric	Allowance and charges can be expressed in different ways. By using percentage, they are expressed as a percentage of another amount, e.g. the base amount.	1..1	Numeric. Content Numeric. Format. Text		No Restrictions
			RatePerUnit	Amount Percent Group. Choice_ Association. Allowance Charge Unit Rate	This information on RatePerUnit for MonetaryAmountOrPercentage.	1..1			
RatePerUnit				Allowance Charge Unit	The rate per unit is specified as a monetary amount per unit, as a				

Class (ABIE)	Attribute (BBIE)	Association (ASBIE)	Secondary Class	Official Dictionary Entry Name	Definition	Multiplicity	Data Type Components	Related Requirements	Facets
				Rate. Details	measurement such as a quantity, weight, or dimension, or as a percentage per unit.				
	allowanceOrChargeRatePerUnit			Allowance Charge Unit Rate. Value. Numeric	Allowance/charge per unit expressed as a figure without decimals.	1..1	Numeric. Content Numeric. Format. Text		totalDigits='35'
	amountPerUnit			Allowance Charge Unit Rate. Value. Numeric	Allowance/charge per unit expressed as an amount.	0..1	Numeric. Content Numeric. Format. Text		No Restrictions
	measurementPerUnit			Allowance Charge Unit Rate. Value. Numeric	The allowance/charge rate per unit defined as a measurement. E.g. per ton	0..1	Numeric. Content Numeric. Format. Text		No Restrictions
	percentagePerUnit			Allowance Charge Unit Rate. Value. Percent_Numeric	Allowance/charge per unit expressed as a percentage.	0..1	Numeric. Content		No Restrictions

3.6.3. Class Diagram: Payment Terms

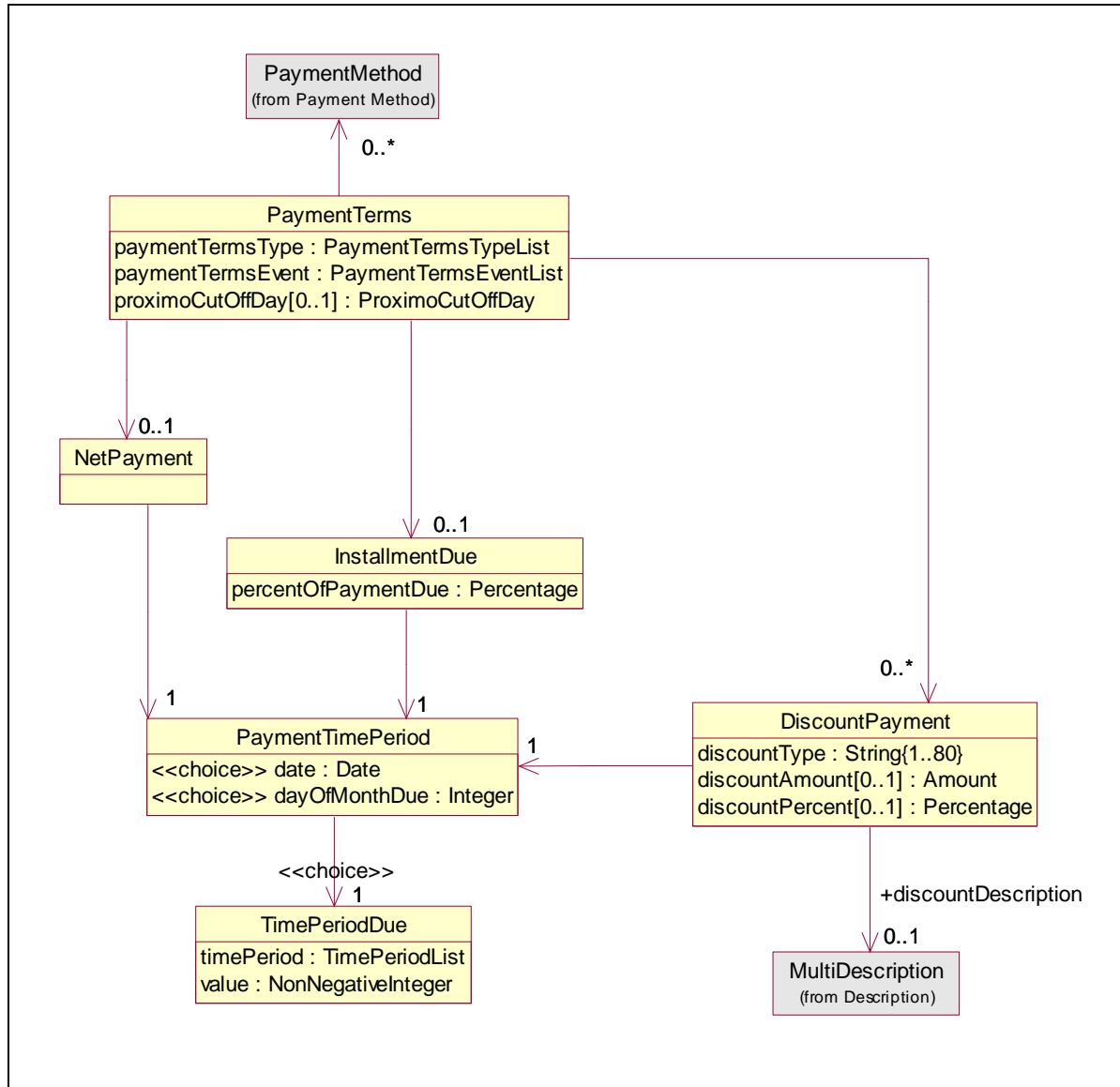

3.6.4. GDD Report: Payment Terms

Class (ABIE)	Attribute (BBIE)	Association (ASBIE)	Secondary Class	Official Dictionary Entry Name	Definition	Multiplicity	Data Type Components	Related Requirements	Facets
DiscountPayment				Discount_Payment Due. Details	This class is used to describe the amount for a discounted payment. Zero or more discounts may be specified using this class. The discount amount is expressed as a percent and is based on the number of days by which the payment must be made to earn the discount. For each discount, a time period is required to specify the percent discount earned.				
	discount Amount			Discount_Payment Due. Discount Amount. Amount	The deduction represented in amount format.	0..1	Amount. Content Amount Currency. Code List Version. Identifier		No restrictions Facets constrained by code list values
	discount Percent			Discount_Payment Due. Percent Of Payment. Numeric	The deduction represented in percentage.	0..1	Numeric. Content Numeric. Format. Text		No Restrictions
	discount Type			Discount_Payment Due. Discount Type. Text	A code that specifies the type of payment discount.	1..1	Text. Content		minLength='1' maxLength='80'
		discountDescription	MultiDescription	Discount_Payment Due. Description. Multi-language Description	A text field describing the discount.	0..1			
			PaymentTimePeriod	Discount_Payment Due. Terms Discount Due. Payment Due	This information on PaymentTimePeriod for DiscountPayment.	1..1			
InstallmentDue				Installment_Payment Due. Details	This class is used to specify the percentage amount of the payment due for the defined PaymentTimePeriod.				
	percentOfPaymentDue			Installment_Payment Due. Percent Of Payment. Percent_Numeric	specifies the exact amount of the payment due this payment period. The amount is expressed as a percent. The percent is sent with a decimal point only when needed, e.g., 10.5% is sent as 10.5.	1..1	Numeric. Content Numeric. Format. Text		No Restrictions
			PaymentTimePeriod	Installment_Payment Due.	This information on PaymentTimePeriod for InstallmentDue.	1..1			

Class (ABIE)	Attribute (BBIE)	Association (ASBIE)	Secondary Class	Official Dictionary Entry Name	Definition	Multiplicity	Data Type Components	Related Requirements	Facets
				Payment Time Period. Payment Due					
NetPayment				Net_ Payment Due. Details	If used, a time period is required to specify when the payment is due.				
			PaymentTimePeriod	Net_ Payment Due. Association. Payment Due	The time period in which a payment is due may be specified in one of three ways:	1..1			
PaymentTerms				Payment Terms. Details	This class is the root class for the message.				
	payment TermsEvent			Payment Terms. Event Type. Date Time	Provides the payment terms event from a code list.	1..1	Date Time. Content Date Time. Format. Text		No restrictions
	payment TermsType			Payment Terms. Payment Terms Type. Payment Terms_ Code	Required to define specific payment terms.	1..1	Date Time. Content Date Time. Format. Text		No restrictions
	proximo CutoffDay			Payment Terms. Proximo Cut-off Day. Integer_ Numeric	This class is used in conjunction with the payment term 'Proximo'. It contains a numeric value for the day of the month.value – The day of the month payment becomes due. value is mandatory.	0..1	Numeric. Content		No restrictions
			DiscountPayment	Payment Terms. Association. Discount_ Payment Due	This information on DiscountPayment for PaymentTerms.	0..*			
			InstallmentDue	Payment Terms. Association. Installment_ Payment Due	This information on InstallmentDue for PaymentTerms.	0..1			
			NetPayment	Payment Terms. Association. Net_ Payment Due	This information on NetPayment for PaymentTerms.	0..1			
			PaymentMethod	Payment Terms. Association. Pay_ Payment Method	This information on PaymentMethod for PaymentTerms.	0..*			
PaymentTimePeriod				Payment Due. Details	Provides the payment time period information.				
	date			Payment Due. Choice_ Date. Date_ Date Time	The time at which an event occurs, expressed as a day	1..1	Date Time. Content		No Restrictions

Class (ABIE)	Attribute (BBIE)	Association (ASBIE)	Secondary Class	Official Dictionary Entry Name	Definition	Multiplicity	Data Type Components	Related Requirements	Facets
	dayOfMonthDue			Payment Due. Choice_ Day Of Month. Numeric	The time at which a payment is due, expressed as a day of the month.	1..1	Numeric. Content Numeric. Format. Text		No Restrictions
			TimePeriod Due	Payment Due. Choice_ Association. Time Period	A time period, in which a number (the time period) is specified in terms of days, weeks, or months.	1..1			
TimePeriodDue				Time Period. Details	The payment time period in which the payment becomes due is expressed as a numeric value.				
	timePeriod			Time Period. Type. Code	The time span within which this event takes place	1..1	Code. Content Code List. Agency. Identifier Code List. Agency Name. Text		Facets constrained by code list values
	value			Time Period. Length. Duration_ Measure	Numeric value describing the time period in which the payment comes due. value is mandatory.	1..1	Code. Content Code List. Agency. Identifier Code List. Agency Name. Text		Facets constrained by code list values

4. Code Lists

4.1. AccountNumberTypeList

Code Value	Code Value Definition
01_TIME_DEPOSIT	The resource value of a time deposit is the net amount due after penalties are imposed for early withdrawal. If the funds cannot be withdrawn before maturity, the time deposit is not a resource until it matures. Time deposits include but are not limited to certificates of deposit, savings certificates, and individual retirement accounts (IRAs)
03_CHECKING_ACCOUNT	US term corresponding to "current account" in the UK. A demand deposit account, withdrawals from which may be made by a written, negotiable instrument.
10_BUSINESS_ACCOUNT	An identifying number or code assigned by issuing authorities to manage business activities. Note: 1. This code value will be removed effective with directory D.04A. (UN/CEFACT)

4.2. AdditionalPartyIdentificationList

Code Value	Code Value Definition
BUYER_ASSIGNED_IDENTIFIER_FOR_A_PARTY	Not Available
DEA_DRUG_ENFORCEMENT_AGENCY	Not Available
DUNS	Not Available
DUNS_PLUS_FOUR	Not Available
FOR_INTERNAL_USE_1	Not Available
FOR_INTERNAL_USE_10	Not Available
FOR_INTERNAL_USE_11	Not Available
FOR_INTERNAL_USE_12	Not Available
FOR_INTERNAL_USE_13	Not Available
FOR_INTERNAL_USE_14	Not Available
FOR_INTERNAL_USE_15	Not Available
FOR_INTERNAL_USE_16	Not Available
FOR_INTERNAL_USE_17	Not Available
FOR_INTERNAL_USE_18	Not Available
FOR_INTERNAL_USE_19	Not Available
FOR_INTERNAL_USE_2	Not Available
FOR_INTERNAL_USE_20	Not Available
FOR_INTERNAL_USE_3	Not Available
FOR_INTERNAL_USE_4	Not Available
FOR_INTERNAL_USE_5	Not Available
FOR_INTERNAL_USE_6	Not Available
FOR_INTERNAL_USE_7	Not Available
FOR_INTERNAL_USE_8	Not Available
FOR_INTERNAL_USE_9	Not Available
HIN_CANADIAN_HEALTHCARE_IDENTIFICATION_NUMBER	Not Available
SCAC	Not Available

Code Value	Code Value Definition
SELLER_ASSIGNED_IDENTIFIER_FOR_A_PARTY	Not Available
SIRET	The SIRET is a 14 digit number composed by the SIREN (9 digits) and an internal classification number of 5n (NIC) identifying the company location. This code value is applicable in the French context and SIRET stands for Système d'Identification du Répertoire des Etablissements
TD_LINK_TRADE_DIMENSIONS	Not Available
UCC_COMMUNICATION_IDENTIFICATION	Not Available
UN_LOCATION_CODE	Not Available
UNKNOWN	Not Available
USDA_ESTABLISHMENT_NUMBER	Not Available

4.3. AdditionalTradeItemIdentificationList

Code Value	Code Value Definition
BUYER_ASSIGNED	Not Available
DISTRIBUTOR_ASSIGNED	The additional Trade Item Identification value populated has been developed and assigned by an entity which purchases and takes title to goods which are then resold / redistributed elsewhere.
FOR_INTERNAL_USE_1	Not Available
FOR_INTERNAL_USE_10	Not Available
FOR_INTERNAL_USE_11	Not Available
FOR_INTERNAL_USE_12	Not Available
FOR_INTERNAL_USE_13	Not Available
FOR_INTERNAL_USE_14	Not Available
FOR_INTERNAL_USE_15	Not Available
FOR_INTERNAL_USE_16	Not Available
FOR_INTERNAL_USE_17	Not Available
FOR_INTERNAL_USE_18	Not Available
FOR_INTERNAL_USE_19	Not Available
FOR_INTERNAL_USE_2	Not Available

Code Value	Code Value Definition
FOR_INTERNAL_USE_20	Not Available
FOR_INTERNAL_USE_3	Not Available
FOR_INTERNAL_USE_4	Not Available
FOR_INTERNAL_USE_5	Not Available
FOR_INTERNAL_USE_6	Not Available
FOR_INTERNAL_USE_7	Not Available
FOR_INTERNAL_USE_8	Not Available
FOR_INTERNAL_USE_9	Not Available
INDUSTRY_ASSIGNED	Not Available
SUPPLIER_ASSIGNED	The additional Trade Item Identification value populated has been developed and assigned by the party which provides service(s) and/or manufactures or otherwise has possession the goods and consigns or makes them available in trade.

4.4. AllowanceChargeList

CodeValue	CodeDefinition
ALLOWANCE_GLOBAL	Not Available
CHARGE_GLOBAL	Not Available
CONSOLIDATED	Not Available
EARLY_PAYMENT	A discount provided if payment is made on or before a specified date.
FLAT_RATE	Not Available
FREE_GOODS	Not Available
FREIGHT_COSTS	Not Available
FUEL_CHARGE	A charge to cover the cost of fuel required to supply the goods
INSURANCE_CHARGE	Not Available
LUMP_SUM	Not Available
MARKUP_FOR_SMALL_VOLUME_PURCHASES	Not Available
PACKING_CHARGES	Not Available

CodeValue	CodeDefinition
PALLET_CHARGE	Charges made by a supplier associated with using a pallet to deliver goods.
QUANTITY_DISCOUNT	A discount based on the number or quantity of goods purchased. For example, 5% discount if more than 100 units are purchased.
SORTING	Code used by the trading partners to communicate sorting allowances or charges that result from organizing returnable items or assets such as glass bottles, pallet platforms, etc.
SPECIAL_HANDLING	Any special charges nominated by the supplier
TRADE_DISCOUNT	A discount normally given by the supplier to buyers who are in the same trade and will be on-selling to the end customer. This discount may also be extended to other buyers with significant purchasing volume.
ULLAGE_AMOUNT	The allowance made for expansion of liquids in a container.
VOLUME_DISCOUNT	A discount based on the value of goods purchased. For example, 3% discount if more than \$1,000 is spent.
WAREHOUSE_AMOUNT	Warehouse storage charges usually incurred when in transit storage is required e.g. between landing on the wharf and trans-shipment to the buyer.

4.5. AllowanceOrChargeList

Code Value	Code Value Definition
ALLOWANCE	Not Available
CHARGE	Not Available

4.6. ApplicationReceiptAcknowledgementStatusList

Code Value	Code Value Definition
ERROR	An error acknowledgement.
RECEIVED	A received acknowledgement.
WARNING	A warning acknowledgement.

4.7. CreditReasonCodeList

Code Value	Code Value Definition
------------	-----------------------

Code Value	Code Value Definition
AGREED_SETTLEMENT	An adjustment made based on an agreement between partners, and selected when the available credit reason codes are not applicable.
BELOW_SPECIFICATION	The goods delivered are of a lower specification than the agreed specification between the buyer and seller.
CASH_DISCOUNT	An adjustment has been made due to the application of a cash discount.
DAMAGED_GOODS	An adjustment due to the damage of goods. <i>Note where damage is identifiable as being caused during transit then transport damage reason code should be used.</i>
DISCOUNT_FOR_LATE_DELIVERY	Penalty amount deducted for late delivery.
EARLY_PAYMENT_ALLOWANCE_ADJUSTMENT	Adjustment results from the application of an early payment allowance this could be for the whole invoice or specific items within the invoice.
GOODS_NOT_DELIVERED	Buyer has not received the goods.
GOODS_ON_CONSIGNMENT	Buyer does not accept invoice(s) charge as it relates to goods where the ownership remains with the seller until sold.
INCORRECT_CHARGE	A charge that was not agreed with the buyer, hence the reason for the credit.
INCORRECT_DISCOUNT	Seller has applied incorrect discount calculation on invoices.
INCORRECT_DUE_DATE_FOR_MONETARY_AMOUNT	Adjustment has been made because an incorrect due date was referred to the previous invoice with regard to the monetary amount.
INVOICE_ERROR	Invoice not in accordance with the order.
PRICE_DISCREPANCY	Seller has charged a price on the invoice that was not agreed with the buyer.
SHORT_DELIVERY	1. When there is shortage on the delivery. <i>Example There is a shortage of 4 units when 10 units are ordered and invoiced, but only 6 units were delivered.</i>
TRADE_DISCOUNT	A discount from the list price of a commodity allowed by a seller to a buyer.
TRANSPORT_DAMAGE	2. Damage occurred during transit of goods. Note where damage is identifiable as being caused during transit then transport damage reason code should be used.
WRONG_DELIVERY	Goods returned not ordered.
WRONG_INVOICE	Wrong monetary amount resulting from incorrect free goods quantity.

4.8. DocumentCommandList

Code Value	Code Value Definition
ADD	Add

Code Value	Code Value Definition
CHANGE_BY_REFRESH	Change By Refresh
CORRECT	Correct
DELETE	Delete

4.9. DocumentStatusList

Code Value	Code Value Definition
ADDITIONAL_TRANSMISSION	Message already transmitted via another communication channel. This transmission provides electronically processable data only. The French tax authorities ask to distinguish the different transmission modes for the invoices in case of control
COPY	Not Available
ORIGINAL	Not Available
REPLACE	Indicates that the original document that was sent should be replaced with the new document. This is only possible when the original document has not yet been processed in the recipient's application.

4.10. EffectiveDateList

Code Value	Code Value Definition
EFFECTIVE_DATE	Not Available
EXPIRATION_DATE	Not Available
FIRST_ARRIVAL_DATE	Not Available
FIRST_ORDER_DATE	Not Available
FIRST_SHIP_DATE	Not Available
LAST_ARRIVAL_DATE	Not Available
LAST_ORDER_DATE	Not Available
LAST_SHIP_DATE	Not Available

4.11. ErrorOrWarningList

Code Value	Code Value Definition
------------	-----------------------

Code Value	Code Value Definition
APPLICATION_ROUTING_ERROR	Application Routing Error
ARTICLE_OUT_OF_ASSORTMENT	Article normally part of a standard assortment is unavailable.
BLOCKED_ARTICLE	Article has been blocked by supplier, e.g. for the reason of quality problems.
BUSINESS_SCOPE_BLOCK	Indicates the type of scope, the identifiers for the scope, other supporting information and the scope content itself.
CODE_NOT_MAPPED_TO_APPLICATION	Code Not Mapped to Application.
CUSTOMER_IDENTIFICATION_NUMBER_AND_ENTITY_NAME_DO_NOT_MATCH	Customer Identification Number and Entity Name Do not match
CUSTOMER_IDENTIFICATION_NUMBER_DOES_NOT_EXIST	Customer Identification Number Does not Exist
CUSTOMER_IDENTIFICATION_NUMBER_IS_INVALID	Customer Identification Number is Invalid
CUSTOMER_IDENTIFICATION_NUMBER_IS_MISSING	Customer Identification Number Is Missing
DELIVERY_SLOT_MISSED	Latest time to place order exceeded therefore slot not available.
DELIVERY_SLOT_NOT_VALID_FOR_LOCATION	Requested delivery time slot not valid for that ship to location.
DISCONTINUED_LINE	To cease making or manufacturing.
DOCUMENT_ENCLOSED_IN_THE_FIRST_TRANSMISSION	Documents enclosed in the first transmission
DOCUMENT_ENCLOSED_IN_THE_SECOND_TRANSMISSION	Documents enclosed in the second transmission
DOCUMENT_NOT_ATTACHED	Document not attached
DOCUMENT_NOT_AVAILABLE	Document not available.
DOCUMENT_NOT_REQUIRED_WAIVER_ISSUED	Document not required, waiver issued.
DUPLICATE	Duplicate
GAP_IN_TIME_PERIOD	Expected adjacent, non-overlapping weekly samples but got non-adjacent weekly samples.
INCOMPLETE_MESSAGE	Incomplete Message
INCORRECT_DATE	Incorrect Date
INSTANCE_IDENTIFIER	Descriptor which contains reference information which uniquely identifies this instance of the SBD between the sender and the receiver
INVALID_BUSINESS_PROCESS_CURRENT_STATUS_CODE	Invalid Business Process Current Status Code

Code Value	Code Value Definition
INVALID_BUYER_EVENT_IDENTIFICATION	As a result of an acknowledgement, change, or change in status; the 'buyer' Event ID does not exist
INVALID_BUYER_IDENTIFICATION	Buyer (Trading Partner Identification) is invalid.
INVALID_BUYER_LOCATION_GROUP_IDENTIFICATION	Invalid buyer group location Identification
INVALID_BUYER_LOCATION_IDENTIFICATION	Invalid buyer location identification number
INVALID_DATE	Invalid date
INVALID_PRODUCT_BUYER_GROUP_IDENTIFICATION	Product / Item Buyer Group Identification Number does not exist.
INVALID_PRODUCT_OR_ITEM_IDENTIFICATION	Product / Item Number does not exist
INVALID_PRODUCT_SELLER_GROUP_IDENTIFICATION	Product / Item Seller Group Identification Number does not exist.
INVALID_SELLER_EVENT_IDENTIFICATION	As a result of an acknowledgement, change, or change in status; the 'seller' Event ID does not exist
INVALID_SELLER_IDENTIFICATION	Seller (Trading Partner Identification) is invalid.
INVALID_SELLER_LOCATION_GROUP_IDENTIFICATION	Invalid seller group location Identification
INVALID_SELLER_LOCATION_IDENTIFICATION	Invalid seller location identification number
INVALID_STATUS_TRANSITION	The Status of this Event has changed and does not follow the acceptable status change life cycle.
INVALID_TIME_PERIOD	Example: Expected weekly forecast and received monthly
ITEM_MARKED_FOR_DELETE	Item Marked For Delete.
ITEM_NOT_AUTHORIZED	Item Not Authorized.
ITEM_TEMPORARILY_NOT_AVAILABLE	Item temporarily not available.
MANIFEST_BLOCK	A flag to indicate that there is more than one type of Document in the instance.
MAXIMUM_ORDERED_QUANTITY_EXCEEDED	Number of ordered articles exceeds the maximum quantity, set by supplier for a certain buyer
MESSAGE_UNDER_DEVELOPMENT	Message under development.
MISSING_CODE_FOR_APPLICATION	Missing Code for Application
MISSING_DATA	Missing Data.
MISSING_EFFECTIVE_MESSAGE_DATE	Missing Effective Message Date

Code Value	Code Value Definition
MISSING_IDENTIFICATION_CODE	Missing Identification Code
MISSING_MESSAGE_REFERENCE_NUMBER	Missing Message Reference Number
MISSING_OR_INVALID_DUNS_NUMBER	Missing or Invalid DUNS Number
MISSING_OR_INVALID_LOCATION	Missing or Invalid Location
MISSING_OR_INVALID_MESSAGE_CODE	Missing or Invalid Message Code
MISSING_OR_INVALID_SCAC	Missing or Invalid SCAC
MISSING_OR_INVALID_UPC_CODE	Missing or Invalid U.P.C. Code
NOT_PERMITTED_BY_LAW	Article may not be delivered to certain buyers because this is not permitted by law, e.g. the buyer is not licensed for buying opiates.
OTHER_UNLISTED_REASON	Other Unlisted Reason
OVERLAPPING_TIME_PERIOD	Expected adjacent, non-overlapping weekly samples, but got overlapping weekly samples.
PARTICIPATING_LOCATION	Number of Participating Locations does not equal the number of Locations communicated in the detail.
PARTICIPATION_PERCENT	Percent of all participating locations
PRODUCT_NOT_VALID_FOR_LOCATION	Requested product not valid for that ship to location.
PRODUCT_OUT_OF_STOCK	Product out of stock.
RECEIVED_AFTER_CUTOFF_DATE_OR_TIME	Received After Cutoff Date or Time
SENDER_NOT_AUTHORIZED_FOR_THIS_MESSAGE	Sender Not Authorized for this message
STANDARD_BUSINESS_DOCUMENT_STANDARD_TYPE	Originator of the type of the Business Data standard, e.g. SWIFT, OAG, used.
STANDARD_STANDARD_BUSINESS_DOCUMENT_STANDARD_TYPE	**DEPRECATE for MAJOR VERSION**Originator of the type of the Business Data standard, e.g. SWIFT, OAG, used.
TO_ARRIVE_BY_SEPARATE_XML_MESSAGE	To arrive by separate XML message
TYPE	A logical indicator representing the type of Business Data being sent or the named type of business data.
TYPE_VERSION	(Standard Business Document. Standard Type Version.Identifier): Descriptor which contains versioning information or number of the standard that defines the document which is specified in the 'Type' data element, e.g. D.96A.

Code Value	Code Value Definition
UNAUTHORIZED_BUSINESS_PROCESS_STATE	Unauthorized Business Process State code.
UNAUTHORIZED_BUSINESS_SERVICE_ACTION_CODE	Unauthorized Business Service Action Code.

4.12. InvoiceTypeCodeList

Code Value	Code Value Definition
AGREED_TERMS	Claim for payment of goods or services based upon terms agreed on a bi-lateral basis between the trading partners.
CORRECTED_INVOICE	Claim for payment of goods and services that includes revised information differing from an earlier submission of the same claim for payment
CREDIT_NOTE	Credit correction of an earlier exchanged claim for payment by an invoice or any other claim for an identified and agreed financial discrepancy.
DEBIT_NOTE	Debit correction of an earlier exchanged claim for payment by an invoice or any other claim for an identified and agreed financial discrepancy.
INVOICE	Claim for payment for goods or services supplied under conditions agreed between the seller and the buyer, seller originated.
PRO_FORMA_INVOICE	Document or message serving as a preliminary invoice, containing – on the whole - the same information as the final invoice, but not actually claiming payment.
SELF_BILLED_CREDIT_NOTE	Credit correction of an earlier exchanged claim for payment by a (Self Billed) invoice or any other claim for an identified and agreed financial discrepancy, buyer originated.
SELF_BILLED_INVOICE	Claim for payment for goods or services supplied under conditions agreed between the seller and the buyer, buyer originated.
TAX_INVOICE	Claim for payment for goods or services supplied under conditions agreed between the seller and the buyer, seller originated for taxation purposes.

4.13. MeasurementTypeCodeList

Code Value	Code Value Definition
DECLARED_NET_WEIGHT	Not Available
GROSS_VOLUME	Not Available
NET_VOLUME	Not Available

Code Value	Code Value Definition
TARE_WEIGHT	Not Available
TOTAL_GROSS_WEIGHT	Not Available
UNIT_GROSS_WEIGHT	Not Available
UNIT_NET_WEIGHT	Not Available

4.14. NonBinaryLogicCodeList

Code Value	Code Value Definition
FALSE	Negative value.
NOT_APPLICABLE	A statement that an affirmative or negative response is not required for the attribute.
TRUE	Affirmative value.
UNSPECIFIED	Value not stated.

4.15. PaymentFormatList

Code Value	Code Value Definition
CCD	Not Available
CCP	Not Available
CTX	Not Available
PPD	Not Available
PPP	Not Available

4.16. PaymentMethodList

Code Value	Code Value Definition
BANK_CHEQUE	Not Available
BANK_GIRO	Not Available
BANKERS_DRAFT	Not Available
BOOKENTRY_CREDIT	Not Available

Code Value	Code Value Definition
BOOKENTRY_DEBIT	Not Available
BOP	Not Available
CASH	Not Available
CERTIFIED_CHEQUE	Not Available
CHEQUE	Not Available
CREDIT_CARD	Not Available
DEBIT_CARD	Not Available
ELECTRONIC_CREDIT_ACH	Not Available
ELECTRONIC_DEBIT_ACH	Not Available
FED_WIRE_NON_REPETITIVE	Not Available
FED_WIRE_REPETITIVE	Not Available
INTERNATIONAL_WIRE	Not Available
LETTER_OF_CREDIT	Not Available
POSTGIRO	Not Available
WIRE_TRANSFER_CREDIT	Not Available
WIRE_TRANSFER_DEBIT	Not Available

4.17. PaymentTermsEventList

Code Value	Code Value Definition
AFTER_DATE_OF_DELIVERY	Not Available
ANTICIPATED_DELIVERY_DATE	Not Available
DATE_INVOICE_RECEIVED	Not Available
DATE_OF_DELIVERY_TO_SITE	Not Available
DATE_OF_INVOICE	Not Available
DATE_OF_SHIPMENT_AS_EVIDENCED_BY_TRANSPORT_DOCUMENTS	Not Available
EFFECTIVE_DATE	Not Available
INVOICE_TRANSMISSION_DATE	Not Available

Code Value	Code Value Definition
PRIOR_TO_DATE_OF_DELIVERY	Not Available
RECEIPT_OF_GOODS	Not Available

4.18. PaymentTermsTypeList

Code Value	Code Value Definition
BASIC_DISCOUNT_OFFERED	Payment term is basic discount offered.
BASIC_NET	Payment conditions normally applied.
DEFERRED	Payment term is deferred.
DISCOUNT	Payment term is discount.
DISCOUNT_AFTER_DEDUCTING_FREIGHT	Payment term is discount after deducting freight.
DISCOUNT_NOT_APPLICABLE	Payment term is discount not applicable.
ELECTIVE	Payment term is to be chosen by buyer (from options separately advised).
END_OF_MONTH	Payment term is end of month.
EXTENDED	Payment term is extended.
FIXED_DATE	Payment term is fixed date.
INSTANT	Payment term is due on receipt of invoice.
MIXED	Different payment terms negotiated under a documentary credit.
NO_CHARGE	There is no charge associated to the payment term.
PAYMENT_BY_INSTALLMENT	Payment term is payment by installment.
PENALTY_TERMS	Payment terms on which penalties apply. Penalty terms apply in case of non compliance to agreed payment terms.
PREVIOUSLY_AGREED_UPON	Payment term is previously agreed upon.
PROXIMO	Payment term is in the next month after present.
VALUTA	Value date, which is a prolongation of the terms for payment

4.19. ResponseStatusList

Code Value	Code Value Definition
ACCEPTED	Not Available
MODIFIED	Not Available
REJECTED	Not Available

4.20. ServiceLevelCodeList

Code Value	Code Value Definition
AUTHORIZED_RETURN_SERVICE	Not Available
CONSIGNEE_BILLING_SERVICE	Not Available
DELIVERY_CONFIRMATION	Not Available
EXPEDITED_SERVICE	Not Available
EXPEDITED_SERVICE_WORLDWIDE	Not Available
EXPRESS_SERVICE	Not Available
EXPRESS_SERVICE_PLUS	Not Available
GROUND	Not Available
GROUND_CX_EXPRESS_SERVICE	Not Available
MULTIWEIGHT	Not Available
MUTUALLY_DEFINED	Not Available
NEXT_DAY_AIR	Not Available
NEXT_DAY_PM	Not Available
NEXT_MORNING	Not Available
PRIMARY_SERVICE_AREA_NEXT_DAY_BY_1030	Not Available
PRIMARY_SERVICE_AREA_NEXT_DAY_BY_1700	Not Available
SAME_DAY	Not Available
SATURDAY	Not Available
SATURDAY_PICKUP	Not Available
SECOND_DAY_AIR	Not Available

Code Value	Code Value Definition
SECOND_MORNING	Not Available
STANDARD_GROUND_HUNDRED_WEIGHT	Not Available
STANDARD_SERVICE	Not Available
THREE_DAY_SERVICE	Not Available

4.21. SettlementList

Code Value	Code Value Definition
BILL_BACK	Not Available
CHARGE_TO_BE_PAID_BY_CUSTOMER	Not Available
CHARGE_TO_BE_PAID_BY_VENDOR	Not Available
CREDIT_CUSTOMER_ACCOUNT	Not Available
ITEM_ACCRUALS	Not Available
OFF_INVOICE	Not Available
VENDOR_ACCRUALS	Not Available
VENDOR_CHECK	Not Available

4.22. ShipmentSpecialHandlingCodeList

Code Value	Code Value Definition
AM_DELIVERY_REQUIREMENT	Delivery must be made in the AM (morning) local time.
BLIND_SHIPMENT	Shipment where the true origin is hidden from the receiver.
DEFERRED_DELIVERY	Delivery postponed by either the shipper or receiver.
DISPOSE_OF_RESIDUE_HEEL	Loading of shipment should not commence until residue heel has been properly disposed of. Residue Heel forms from sediment accumulated from previous shipments in the same container.
DO_NOT_BREAK_DOWN	Instructions to not break down unitized freight during the shipping process.
DO_NOT_FREEZE	Shipment contents must not be exposed to freezing temperatures.

Code Value	Code Value Definition
DO_NOT_SPLIT_SHIPMENT	Shipment must not be broken or split into multiple shipments.
DO_NOT_STACK	Shipment contents cannot be stacked or piled on top or underneath any other shipment contents.
DROP_OFF_DELIVERY	Delivery location requires equipment to be dropped.
DROP_YARD	A yard location where equipment can be dropped.
EXCLUSIVE_USE_OF_VEHICLE	Use of the equipment is limited only to the specific shipment.
EXPEDITED_SERVICE	Monitored to facilitate quicker service.
EXTRA_DRIVER	Additional driver required to meet service requirements.
FRAGILE_HANDLE_WITH_CARE	Shipment contents are fragile and extra care should be taken during shipping.
GUARANTEED	Delivery of the shipment is guaranteed for a specific date and/or time.
HEAT	Shipment requires heat to maintain contents condition for conveyance and/or delivery.
HEAT_IN_TRANSIT	Shipment will be conveyed using equipment equipped with a heating system.
HEAT_SPECIAL	Special Heating Equipment necessary to maintain shipment temperature or storage and/or delivery.
HEAT_WITH_STEAM	Safety concerns pertaining to a volatile component of the shipment requires steam heating equipment.
INSIDE_PICKUP	Pickup done within a structure.
KEEP_MATERIAL_DRY	Shipment contents cannot be allowed to get wet, must be kept dry.
LOAD_ON_TOP_OF_RESIDUE_HEEL	Motor Fuel shipment is to be loaded on top of a residue heel. Residue Heel forms from sediment accumulated from previous shipments in the same container.
LOADED_TO_FULL_VISIBLE_CAPACITY	Assure equipment is visibly loaded to full capacity.
NEXT_DAY_DELIVERY	Shipment must be delivered within 24 business hours of pickup at the shipper.
NOTIFY_CONSIGNEE_BEFORE_DELIVERY	Carrier must contact delivery location prior to arriving to arrange delivery appointment.
PERISHABLE	Shipment contents are perishable and special care should be used to deliver it.
PM_DELIVERY_REQUIRED	Delivery must be made in the PM (afternoon or evening) local time.
PROTECT_FROM_HEAT	Shipment contents should avoid heat, as defined by shipper, and may require equipment equipped with cooling system.
REFRIGERATED	Shipment must use equipment equipped with cooling system.
RESIDENTIAL_DELIVERY	Delivery is in residential area.

Code Value	Code Value Definition
ROUND_TRIP_SERVICE	Not Available
SECOND_DAY_DELIVERY	Shipment must be delivered within 48 business hours of pickup at the shipper.
SECURITY_SIGNATURE_SERVICE	Delivery requirements to assure security signature on paperwork.
SINGLE_SHIPMENT	One shipment tendered to the carrier.
TEMPERATURE_CONTROL	Shipment must use equipment equipped with heating and/or cooling systems to keep the contents within a temperature range as defined by the shipper.
TOP_FREIGHT_ONLY	Shipment contents may be stacked on top of other contents, but may not have any other contents stacked or piled on top of it.

4.23. TimePeriodList

Code Value	Code Value Definition
DAYS	Not Available
MONTHS	Not Available
WEEKS	Not Available

4.24. TransportationMethodTypeCodeList

Code Value	Code Value Definition
AIR	A movement of material by air
AIR_CHARTER	A movement of material by chartered aircraft.
AIR_EXPRESS	A movement of material by air express service.
AIR_FREIGHT	A movement of material by freight air
BEST_WAY_SHIPPERS_OPTION	A movement the best way, choice is left to the shipper.
BOOK_POSTAL	A movement of material by postal of or relating to the system for delivering mail.
BUS	To specify that the means of transportation is a bus.
CAB	To specify that the means of transport is a taxi.
CONSOLIDATION	A movement of multiple shipments to a single destination.
CONTRACT_CARRIER	An agreement between two or more parties, especially one that is written or spoken and enforceable by law.

Code Value	Code Value Definition
CUSTOMER_PICKUP	Cargo will be picked up by the customer.
CUSTOMER_PICKUP_OR_CUSTOMERS_EXPENSE	Cargo will be picked up by the customer, or else it will be picked up at his expense
EXPEDITED_TRUCK	A movement of material by expedited truck.
GEOGRAPHIC_RECEIVING	A collection of shipments that involve a single origin, multiple destinations, and a single trailer, and are paid under a single freight bill.
GEOGRAPHIC_RECEIVING_SHIPPING	A collection of shipments that involve a single origin, multiple destinations, and a single trailer, and are paid under a single freight bill.
GEOGRAPHIC_SHIPPING	A collection of shipments that involve a single origin, multiple destinations, and a single trailer, and are paid under a single freight bill.
INLAND_WATERWAY	Transport by which goods are moved via an inland body of water.
INTERMODAL_PIGGYBACK	A tractor trailer is placed (usually without the tractor) on a flat car or specially-designed rail car.
LESS_THAN_TRUCK_LOAD	The transportation of relatively small freight. The alternatives to LTL carriers are parcel carriers or full truckload carriers.
MOTOR	A movement of material by motor carrier means a contract carrier, a common carrier or a private carrier of property or passengers by motor vehicle.
MOTOR_COMMON_CARRIER	Any person who or which undertakes, whether directly or by a lease or any other arrangement, to transport passengers or household goods.
MOTOR_FLATBED	Trailer or container without raised sides or ends.
MOTOR_PACKAGE_CARRIER	A movement of material by motor package carrier.
MOTOR_TRUCKLOAD	A movement of material by motor truckload.
MOTOR_VAN	A movement of material by motor van.
MUTUALLY_DEFINED	Mutually defined transport.
OCEAN	Transport by sea / ocean.
PARCEL_POST	Transport by parcel postal service that handles packages.
PIPELINE	Transport by pipeline.
POOL_TO_POOL	Transport by pool to pool.
POOLED_AIR	A consolidated air shipment with other shipments into full air shipments bound for the same destination, or by pooling your shipments on one air shipment headed in a general line to all your delivery points. Either way, it means your shipments are not handled again until they arrive, which minimizes damage and loss claims and expedites transit times.

Code Value	Code Value Definition
POOLED_PIGGYBACK	A consolidated movement of material by a trailer on a railcar.
POOLED_PIGGYPACK	<>A consolidated movement of material by a trailer on a railcar.
POOLED_RAIL	A consolidated rail shipment with other shipments into full rail shipments bound for the same destination, or by pooling your shipments on one rail shipment headed in a general line to all your delivery points. Either way, it means your shipments are not handled again until they arrive, which minimizes damage and loss claims and expedites transit times.
POOLED_TRUCK	A consolidated shipment with other shipments into full truckloads bound for the same destination, or by pooling your shipments on one truck headed in a general line to all your delivery points. Either way, it means your shipments are not handled again until they arrive, which minimizes damage and loss claims and expedites transit times.
PRIVATE_CARRIER	A code indicating privately owned transport.
PRIVATE_PARCEL_SERVICE	A code indicating privately owned parcel service.
PRIVATE_VESSEL	A code indicating privately owned ship.
RAIL	A movement of material to the consignee via rail.
ROADTRAILER	In railroad terminology a roadtrailer is a highway trailer that is specially equipped for use in railroad intermodal service. The advantage of using roadtrailers is that due to their construction, the trailers can be pulled directly behind other freight equipment without the use of trailer flatcars.
SEA_AIR	The cargo is being moved by more than one transport means in succession: first by ship then by plane.
STEAM_SHIP	A steamboat or steamship, sometimes called a steamer, is a boat or vessel that is propelled by steam power driving a propeller or paddlewheel. The term steamboat is usually used to refer to smaller steam-powered boats working on lakes and rivers, particularly riverboats in the USA; steamship generally refers to steam powered ships capable of carrying a (ship's) boat. Nuclear powered ships and submarines use steam to drive turbines, but are not referred to as steamships or steamboats.
SUPPLIER_TRUCK	A code indicating transport by a truck owned by the supplier.

4.25. VATCategoryCodeList

Code Value	Code Value Definition
DOMESTIC_REVERSE_CHARGE	Code specifying that the rate is based upon the domestic reverse charge VAT treatment. This code value is particularly pertinent to the UK context.
EXEMPT_FROM_TAX	Code specifying that taxes are not applicable. All items in the transaction or a specific line item are exempt from tax.

Code Value	Code Value Definition
FREE_EXPORT_ITEM	Code specifying that the item is free export and taxes are not charged.
HIGHER_RATE	Code specifying a higher rate. All items in the transaction or a specific line item are taxed at the higher rate of tax.
LOWER_RATE	A code specifying a lower rate. All items in the transaction or a specific line item are taxed at the lower rate of tax.
MIXED_TAX_RATE	Code specifying that the rate is based on mixed tax. Transaction includes item taxed at different rates.
SERVICES_OUTSIDE_SCOPE_OF_TAX	Code specifying that taxes are not applicable to the services.
STANDARD_RATE	Code specifying the standard rate. All items in the transaction or a specific line item are taxed at the standard rate of tax.
VALUE_ADDED_TAX_NOT_NOW_DUE_FOR_PAYMENT	A code to indicate that the Value Added Tax (VAT) amount which is due on the current invoice is to be paid on receipt of a separate VAT payment request. The value added tax is not due for payment now.
ZERO_RATED_GOODS	Code specifying that the goods are at a zero rate. All items in the transaction or a specific line item are zero tax rated.

4.26. VATPaymentDueList

Code Value	Code Value Definition
DUTY_TAX_OR_FEE_PAYMENT_DUE_ON_INVOICE_ISSUE_DATE	Duty, tax or fee payment is due on the date when the invoice is issued.
DUTY_TAX_OR_FEE_PAYMENT_DUE_ON_INVOICE_PAYMENT_DATE	Duty, tax or fee payment is due on the date when the invoice is paid

5. Summary of Changes

Change	BMS Doc Version	Associated CR Number
<p>Section 3.5.3 Trade Item Identification</p> <p>Renamed Class FROM:CommonAdditionalTradeItemIdentification TO : AdditionalTradeItemIdentification</p> <p>Deleted role name +additionalTradeItemIdentification as the revised class name defaults to the same name.</p>	0.1.2	For consistency to Party Identification structure.
<p>Section 3.4.1 Extended Data Type</p> <p>Renamed Attributes in Class Character Attribute FROM: character Attribute TO : characterString Class TimeZone Attribute FROM: timeZone Attribute TO : timeZoneDesignator Class Version Attribute FROM: version Attribute TO : versionIdentification</p>	0.1.2	<p>To differentiate the class name and attribute name.</p> <p>Helps to avoid the duplicate data element names in our standards.</p>
Removed Section 4.1 and 4.1.1 Application Receipt Acknowledgment	0.1.2	<p>Removed as ARA is a message and is contained in it's own BRD</p> <p>P4CL: 4844 BRD Ver: 0.41.2</p>
Finished Plan Common section 4.7 to 4.7.6	0.1.2	Finished the remaining balance of 2.0 publication common library

Change	BMS Doc Version	Associated CR Number
Section 3.2.1. Amount Renamed Attribute in Class Character and corrected dataType Typo Attribute FROM: currencyISOCode : ISO4217Code Attribute TO: currencyCode : ISO4217_Code	0.1.3	Avoid duplicate element name in message.
Corrected dataType Typo in following classes and section Class: Description (3.2.3.) Class: LongDescription (3.2.4) Attribute FROM: language : ISO639Code Attribute TO : language : ISO639_Code:	0.1.3	
Renamed class BinarySignature (4.2.3.) FROM: BinarySignature TO : BinarySignatureInformation	0.1.3	Avoid duplicate element name in message.
Change in role name to match BRD. Order Logistical Information (4.4.1) OrderLogisticalDateGroup associated to LogisticalDate Role FROM: requestedDeliveryDateUltimateConsignee Role TO : requestedDeliveryDateAtUltimateConsignee	0.1.3	Consistency and matches the BRD requirements.
Section 4.9.2 Name And Address Renamed Attribute in Class NameAndAddress Attribute FROM: currencyISOCode : ISO4217_Code Attribute TO : currencyCode : ISO4217_Code	0.1.3	Avoid duplicate element name in message.
Section 4.11.1 Allowance Charge Change in role name AllowanceCharge associated to MultiDescription Role FROM: description Role TO : allowanceChargeDescription	0.1.3	Avoid duplicate element name in message.

Change	BMS Doc Version	Associated CR Number
Section 3.5.2 Party Identification Change attribute name in AdditionalPartyIdentification Attribute FROM: additionalPartyIdentification Attribute TO : additionalPartyIdentificationValue	0.1.4	Avoid duplicate element name
Added code list to common library in section 1.5.4.	0.1.4	Added code list
Updated Deliver Reference Code List added following additional code values ACCOUNTS_RECEIVABLE_CUSTOMER_ACCOUNT AGENTS_SHIPMENT_NUMBER APPROPRIATION_NUMBER DEALER_ORDER_NUMBER EMPLOYERS_IDENTIFICATION_NUMBER FEDERAL_TAXPAYERS_IDENTIFICATION_NUMBER FOOD_AND_DRUG_ADMINISTRATION_FDA_PRODUCT_CODE INVALID_ACCOUNT_REASON_CODE LOCATION_NUMBER MANIFEST_KEY_NUMBER NEXT_AVAILABLE_FLIGHT_JOB_NUMBER PACKAGE_NUMBER PART_NUMBER PORT_CODE PRODUCTION_CODE PURCHASE_ORDER_ITEM_NUMBER PURCHASE_REQUISITION_NUMBER SALESPERSON SERIAL_NUMBER SERVICE_REQUEST_NUMBER SOCIAL_SECURITY_NUMBER SOFTWARE_APPLICATION_NUMBER VENDOR_IDENTIFICATION_NUMBER	0.1.5	Updated Code List

Change	BMS Doc Version	Associated CR Number
Replaced existing Exception Status Type Code List with the following values EXCEPTION_REASON_ONLY EXCEPTION_REASON_WITH_RESOLUTION EXCEPTION_REASON_WITH_STATUS	0.1.5	Updated Code List
Document Class: 3.1.2. For Datatype replaced Version=2.0 to	0.1.6.	Update
Based on Order Response work Added to Common Library section 3.1.4 ResponsesDocument This is similar to the Document structure, but this should be used for document responses.	0.1.7	New Additions
Based on work from MultiShipTo and Order Created new class: TradeAgreement section 4.4.4	0.1.7	New Additions
Based on work from MultiShipTo and Order Created new class: Transportation Mode Section 4.9.4	0.1.7	New Addition
Based on work from MultiShipTo and Order Modified OrderLogisticalInformation section 4.4.1 Created association From: ShipToLogistics TO: TransportationMode class 0..1 Created choice association From: ShipToLogistics TO: NameAndAddress class role +shipToNonCommercial1..1 Created choice association From: ShipToLogistics TO: PartyIdentification class role +shipTo1..1	0.1.7	Modification

Change	BMS Doc Version	Associated CR Number
<p>Based on work from MultiShipTo and Order Modified OrderPartyInformation section 4.4.2</p> <p>Created association From: OrderPartyInformation TO: Contact class role +orderContact0..1</p>	0.1.7	Modification
<p>Based on work from MultiShipTo and Order Modified SimpleOrderLineItem section 4.4.3</p> <p>Created association From: SimpleOrderLineItem TO: TransportationMode class 0..1</p>	0.1.7	Modification
<p>Based on public review from Order BRG. Added an optional unitOfMeasure attribute to the SimpleOrderLineItem class. Section 4.4.3</p> <p>Order rejected the idea to reuse the MeasurementValue class because there requirement was to have an optional UoM.</p>	0.1.8	Modification
<p>Based on Publicatoin 2.0.1 work on Plan. Added missing Code Lists into section 1.5. Following four code lists were added.</p> <p>ConsumerIncentiveTacticTypeCodeList DisplayTacticTypeCodeList FeatureTacticTypeCodeList TradeltemPackingLabelingTacticTypeCodeList</p> <p>EventTacticTypeCode (aggregate of enumerated code lists) Class diagram was inserted in section 4.7.3</p>	0.1.9	<p>Additions to section 1.5</p> <p>Section 4.7.3 Event Tactic Type Code class diagram</p>
<p>Added creationDateTime:DateTime into ResponseDocument Class.</p>	0.1.13	<p>Derived from BSD P4CL: 6359 BSD Title: Order Response BSD Version: 0.1.5</p> <p>Changed enforced based on the public review Order Response BSD</p>

Change	BMS Doc Version	Associated CR Number
<p>New components (new sections):</p> <p><u>Document Reference</u></p> <p><u>Quantity</u></p> <p><u>Logistic Unit Identification</u></p> <p><u>Unit Measurement</u></p> <p><u>Logistic Unit Measurement</u></p> <p><u>Inventory Status Line Item</u></p> <p><u>QuantitySpecification</u></p> <p>Modifications to existing sections:</p> <p><u>Date And Time</u></p> <p>Added class TimeOrDateTimePeriod</p> <p><u>Trade Item Unit Or Logistic Unit</u></p> <p>Split into two sections: 1. Logistic Units and 2. Item Containment</p> <p><u>LogisticUnits</u></p> <p>To class LogisticUnits added following attributes:</p> <p>quantityOfChildren,</p> <p>packageType,</p> <p>childPackageType,</p> <p>and added the following associations:</p> <p>LevelIdentification (+levelId),</p> <p>LevelIdentification (+parentLevelId),</p> <p>LogisticUnitIdentification,</p> <p>LogisticUnitMeasurement</p> <p>and removed attribute Identification</p> <p>and removed association ItemContainment (+itemsContained)</p> <p>Added class LevelIdentification</p> <p><u>ItemContainment</u></p> <p>Class ItemContainment</p> <p>Added inheritance to LineItem</p> <p>Removed attribute quantityContained</p> <p>Added association to TradeItemIdentification (+requestedItemIdentification)</p> <p>Added associations to DetailLevelReference (+customer, +productCertification, +promotionalDeal, +specification) and moved one association (+purchaseOrder)</p> <p>Added associations to DocumentOrDocumentLineReference (+purchaseOrder, +purchaseConditions)</p>	0.2.0	
<p>30-Oct-2009, <u>TradeItem</u>: class was removed</p> <p>Removed class AdditionalItemData</p> <p><u>Transactional Item Data</u></p>	All contents copyright © GS1 2009	Page 99 of 123

Change	BMS Doc Version	Associated CR Number
Added Goods Requirements Line Item.	0.2.1	
Added Extension Point to ItemContainment: Updated GDD Report Updated Item Containment Model ItemContainment class added attribute extension[0..1] : Extension	0.2.2	
Updated Extended Data Types PackageTypeDescriptionCode MeasurementUnitCode	0.2.3	
Added Transportation Payment Method Code List which will replace Deliver Payment Method Code List in next major publication.	0.2.4	
Added QuantityRange to Range package	0.2.6	
GoodsRequirementsLineItem Association to DocumentReference (+purchaseConditions) was changed into DocumentOrDocumentLineReference (+purchaseConditions).	0.2.7	
TransactionallItemData: added attributes countryOfOrigin[0..1] : ISO3166_1Code productQualityIndication[0..1] : Quantity	0.2.8	
Created new class CurrencyExchangeRateInformation currencyConversionFrom : ISO4217_Code currencyConversionTo : ISO4217_Code exchangeRate : Float	0.2.9	
Additional Trade Item Identification List Added 20 qualifiers FOR_INTERNAL_USE_1..20 Additional Party Identification List Added 20 qualifiers FOR_INTERNAL_USE_1..20	0.2.10	
PaymentTerms / Discount Payment added attributes discountAmount[0..1]: Amount discountPercent[0..1]: Percentage	0.2.11	

Change	BMS Doc Version	Associated CR Number
<p>Added Transportation Reference which will replace Deliver Reference</p> <p>Added Transportation Reference Code List which will replace Deliver Reference Code List</p> <p>Added Hazardous Shipment Information which will replace Bill of Lading Hazardous Information</p> <p>Added Invoice following classes into Process Common: Pay Common 1. Tax Information 2. Invoice Party</p> <p>Added Trade Item Price Date Information into Process Common: Trade Item Common</p> <p>Added Dimension into Common Library for Major Pubs 3.0 Release.</p> <p>Added Entertainment Common into Process Common: Trade Item Common</p> <p>Added Out of Box Information into Process Common: Trade Item Common</p> <p>Added Description 2500 Description2500 added attributes language : ISO639_Code text : String{1..2500} MultiDescription2500 added attribute description[1..*] : Description2500</p> <p>Added Description 5000 Description5000 added attributes language : ISO639_Code text : String{1..5000} MultiDescription5000 added attribute description[1..*] : Description5000</p> <p>Need to review Measurement Unit Code List (External) and Package Type Description Code List (External) for next major publication.</p>	<p>0.2.12</p>	

Change	BMS Doc Version	Associated CR Number
Added Receiving Condition Code List into Common Library. Originated from Deliver context, Reused in Pay Advanced Remittance Notice. Added SUBSTITUTED_ITEM in code list.	0.2.13	
Added FMCG Trade Item Identification	0.2.14	
GS1 Code List policy states special characters are not allowed for code names. The change originated from Claims Notification BSD work. Noted are the detail changes to the MessageReasonList. 74_CANCEL_OR_ADJUST_PRIOR_CREDIT_OR_DEBIT_ADJUSTME→ 74_CANCEL_OR_ADJUST_PRIOR_CREDIT_OR_DEBIT_ADJUSTMENT Removed (ERS) 83_EVALUATED_RECEIPT_SETTLEMENT_(ERS)_DELIVERY_CHARGE→ 83_EVALUATED_RECEIPT_SETTLEMENT_DELIVERY_CHARGE Removed parenthesis BM_NET_COLLECTION_EXPENSE_(FACTOR)→ BM_NET_COLLECTION_EXPENSE_FACTOR Removed parenthesis BP_NET_CHARGEBACK_OF_CLIENT_RISK_(FACTOR)→ BP_NET_CHARGEBACK_OF_CLIENT_RISK_FACTOR Replaced % with Percentage E6_GOODS_AND_SERVICES_TAX_0%_RATE_INTERNATIONAL_DOCUMENTATION_WILL_FOLLOW→ E6_GOODS_AND_SERVICES_TAX_0_PERCENTAGE_RATE_INTERNATIONAL_DOCUMENTATION_WILL_FOLLOW RR_HANDLING_CHARGE_FOR_UNREADABLE_ADVANCE_SHIP_NOT→ RR_HANDLING_CHARGE_FOR_UNREADABLE_ADVANCE_SHIP_NOTICE ST_UNAUTHORIZED_AIR_SHIPMENT_CHARGEBACK_IS_THE_DIFFERENCE_BETWEENAIR_AND_GROUND →ST_UNAUTHORIZED_AIR_SHIPMENT_CHARGEBACK_IS_THE_DIFFERENCE_BETWEEN_AIR_AND_GROUND	0.2.15	GS1 code policy not to use special characteristics for code names.
GS1 Code List policy states special characters are not allowed for code names. Noted are the detail changes to the Service Level Code List. Remove colon. PRIMARY_SERVICE_AREA_NEXT_DAY_BY_5:00_PM→ PRIMARY_SERVICE_AREA_NEXT_DAY_BY_1700 PRIMARY_SERVICE_AREA_NEXT_DAY_BY_10:30_AM→ PRIMARY_SERVICE_AREA_NEXT_DAY_BY_1030	0.2.16	
CurrencyExchangeRateInformation Added new optional attribute exchangeRateDate.	0.2.17	n/a

Change	BMS Doc Version	Associated CR Number
<p>Delete targetMarketDescription</p> <p>Rationale</p> <p>The target market is identified with a code sent with "targetMarketCountryCode". The description is useless and requires useless cross checking to control that it matches the code.</p>	0.2.18	05-000389 Source from BRAD Implementation Feedback Phase #1 P4CL: 7983
<p>Moved into Deliver Common.</p> <p>Commodity Group and Equipment Information</p> <p>Process Common Components: Deliver Common: Commodity Group</p> <p>20060301 the work from FTL Load Tender changed from OLD to New. Moved into common as reused in FTL Load Tender and now Transportation Rate Simple Request</p> <p>Old</p> <div data-bbox="436 719 1043 920" style="border: 1px solid black; padding: 5px; margin: 10px 0;"> <p style="text-align: center;">CommodityGroup</p> <p>commodityCode : CommodityCodeList commodityDescription : Description commodityQuantity : Integer commodityWeight : MeasurementValue</p> </div> <p>New</p>	0.2.19	

Change	BMS Doc Version	Associated CR Number
<div data-bbox="323 250 966 789"> <pre> classDiagram class PackageDimension["PackageDimension (from Package Dimension)"] class CommodityGroup["CommodityGroup"] class MultiMeasurementValue["MultiMeasurementValue (from Measurement)"] PackageDimension "0..1" --> CommodityGroup : +commodityDimension CommodityGroup --> MultiMeasurementValue : +netWeight CommodityGroup "0..1" --> MultiMeasurementValue : +grossWeight MultiMeasurementValue --> MultiMeasurementValue : +volume 0..1 </pre> </div> <p data-bbox="436 821 1419 878">Note: 20060301 moved into common as reused in FTL Load Tender and now Transportation Rate Simple Request</p> <div data-bbox="323 906 718 1282"> <pre> classDiagram class EquipmentInformation["EquipmentInformation"] class MultiMeasurementValue["MultiMeasurementValue (from Measurement)"] EquipmentInformation --> MultiMeasurementValue : +equipmentLength </pre> </div>		

Change	BMS Doc Version	Associated CR Number
<p>Changed cardinality from mandatory to optional for flashPointTemperature. Trade Item Hazardous Information associated to Multi Measurement Value</p>  <pre> classDiagram class MultiMeasurementValue["MultiMeasurementValue (from Measurement)"] class TradeItemHazardousInformation["TradeItemHazardousInformation"] MultiMeasurementValue "0..1" -- "*" TradeItemHazardousInformation : +flashPointTemperature class TradeItemHazardousInformation { dangerousGoodsRegulationCode : String{1..3} } </pre>	0.2.20	04-44 BRAD Implementation Feedback Appendix D/E p4CL: 8023 BR 12
Added UN_INFODS_Code to Extended Data Types Class Diagram.	0.2.21	CR 05-000195
Added Payment Discount to Pay Common as it is reused in Advanced Remittance Notification and EU National Extension Pasted in Class Diagram, Need to populate GDD.	0.2.22	
Common Library updated for next major release. Updated Document to reflect Modelling Team recommendation. Remove the redundant Data Description Report and consolidated into a column within GDD report Removed the Code Lists and future work will reference GDD for most current lists. Consoildated Class Diagram and GDD report snapshot. Modelling team performed QA measures against Model and GDD Report. The Common Library Project schedule can be referenced P4CL: 8563	0.2.23	
Common Library Updated for BMS Release Version 2.3 Section 3.8.9 Invoice Tax Information Based on BSD Invoice BMS Release Version 2.3 InvoiceTaxInformation Addition of taxPercentage[0..1]:Percentage{3..2}	0.4.0	07-000128 06-000300 06-000301 06-000302 06-000282 06-000283 06-000285 06-000297 CR 07-00026/27/31

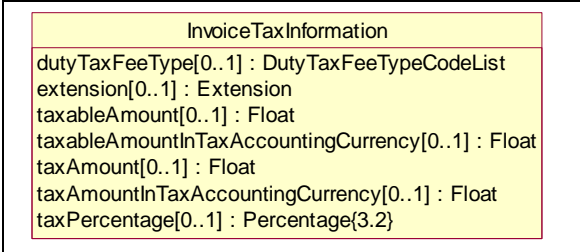

Change	BMS Doc Version	Associated CR Number								
<p>SimpleOrderLineItem Added attribute additionalOrderLineInstruction[0..1]:Description lineItemActionCode[0..1]:OrderLineItemActionCodeList</p> <div data-bbox="323 423 1304 948" style="border: 1px solid black; padding: 10px;"> <pre> classDiagram class LineItem["<<abstract>> LineItem (from Document)"] class SimpleOrderLineItem class TradeItemIdentification["TradeItemIdentification (from Trade Item Identification)"] class MultiAmount["MultiAmount (from Amount)"] class ShipmentTransportationInformation["ShipmentTransportationInformation (from Shipment Transportation Information)"] LineItem < -- SimpleOrderLineItem SimpleOrderLineItem "1" --> TradeItemIdentification SimpleOrderLineItem "0..1" --> MultiAmount : +netPrice SimpleOrderLineItem "0..1" --> ShipmentTransportationInformation : +netAmount </pre> </div> <p>Order Line Item Action Code List: Provides the action required on the line item.</p> <table border="1" data-bbox="623 1062 1346 1446"> <thead> <tr> <th>CodeValue</th> <th>CodeDefinition</th> </tr> </thead> <tbody> <tr> <td>ADDITION</td> <td>This line item is to be added to the original purchase order as a new or additional item. All required data must be transmitted.</td> </tr> <tr> <td>CHANGED</td> <td>This line item is to be changed. The data transmitted replaces the previously held information for the order line item.</td> </tr> <tr> <td>DELETED</td> <td>This line item is to be deleted from the referenced purchase order. No other data for the line item needs to be transmitted.</td> </tr> </tbody> </table>	CodeValue	CodeDefinition	ADDITION	This line item is to be added to the original purchase order as a new or additional item. All required data must be transmitted.	CHANGED	This line item is to be changed. The data transmitted replaces the previously held information for the order line item.	DELETED	This line item is to be deleted from the referenced purchase order. No other data for the line item needs to be transmitted.		
CodeValue	CodeDefinition									
ADDITION	This line item is to be added to the original purchase order as a new or additional item. All required data must be transmitted.									
CHANGED	This line item is to be changed. The data transmitted replaces the previously held information for the order line item.									
DELETED	This line item is to be deleted from the referenced purchase order. No other data for the line item needs to be transmitted.									

Change	BMS Doc Version	Associated CR Number						
<div data-bbox="323 318 1215 922" style="border: 1px solid black; padding: 10px;"> <pre> classDiagram class Document { <<abstract>> } class ResponseDocument { <<abstract>> responseStatusType : ResponseStatusList } class ReferenceDocument { referenceDocumentType : Integer{1..4} referenceIdentification : String referenceDateTime[0..1] : DateTime } class EntityIdentification { <<from Entity Identification>> } Document < -- ResponseDocument ResponseDocument --> "1" EntityIdentification : +responseIdentification ResponseDocument --> "1" ReferenceDocument : +responseToOriginalDocument ReferenceDocument -- > ResponseDocument </pre> <p>Added to ErrorOrWarningList</p> <p>ErrorOrWarningList</p> <p>Added</p> <table border="1" data-bbox="323 1109 1008 1414"> <tr><td>PRODUCT_OUT_OF_STOCK</td></tr> <tr><td>ITEM_TEMPORARILY_NOT_AVAILABLE</td></tr> <tr><td>DELIVERY_SLOT_MISSED</td></tr> <tr><td>DELIVERY_SLOT_NOT_VALID_FOR_LOCATION</td></tr> <tr><td>PRODUCT_NOT_VALID_FOR_LOCATION</td></tr> <tr><td>DISCONTINUED_LINE</td></tr> </table> </div>	PRODUCT_OUT_OF_STOCK	ITEM_TEMPORARILY_NOT_AVAILABLE	DELIVERY_SLOT_MISSED	DELIVERY_SLOT_NOT_VALID_FOR_LOCATION	PRODUCT_NOT_VALID_FOR_LOCATION	DISCONTINUED_LINE		
PRODUCT_OUT_OF_STOCK								
ITEM_TEMPORARILY_NOT_AVAILABLE								
DELIVERY_SLOT_MISSED								
DELIVERY_SLOT_NOT_VALID_FOR_LOCATION								
PRODUCT_NOT_VALID_FOR_LOCATION								
DISCONTINUED_LINE								

Change	BMS Doc Version	Associated CR Number
<p>Simple Order Line Item Changed in SimpleOrderLineItem datatype from Description-->LongDescription additionalOrderLineInstruction[0..1] : Description→ additionalOrderLineInstruction[0..1] : LongDescription</p>	0.4.1	Based on Public Review 200704
<p>GDD Report Trade Item Hazardous Information Aligned the multiplicity of flashPointTemperature to optional 0..1</p> <p>Model and GDD Report Event Tactic Type Code Fixed typo on featureTacticTypeCode : FeatureTacticTypeCodeList</p>	0.4.3	
<p>BMS upgraded for Release 2.4.0 Added Order Header Indicator Structure</p>	0.5.0	<ul style="list-style-type: none"> ■ CR 07-000077 ■

Change	BMS Doc Version	Associated CR Number
<ul style="list-style-type: none"> ▪ Common Library Addition ▪ OrderHeaderIndicator added attributes ▪ isApplicationReceiptAcknowledgementRequired ▪ isOrderFreeOfExciseTaxDuty ▪ <p>Added String Facets to align with the Description field lengths.</p> <p>Despatch Advice Work BMS Release 2.4</p> <p>Added Despatch Information into Deliver Common</p> <p>Note: 200707 added Despatch Information as part of BMS Release 2.4.0 and Common Library Document Version 0.5.0</p>		<ul style="list-style-type: none"> ▪ CR 07-000098 ▪ ▪ CR 07-000103

Change	BMS Doc Version	Associated CR Number
<pre> classDiagram class DespatchInformation { despatchDateTime[0..1] : DateTime loadingDateTime[0..1] : DateTime pickUpDateTime[0..1] : DateTime releaseDateTimeOfSupplier[0..1] : DateTime } class ActualShipping { actualShipDateTime : DateTime estimatedDeliveryDateTime[0..1] : DateTime } class EstimatedDelivery { (from Estimated Delivery) } class TimeOrDateTimePeriod { (from Date and Time) } DespatchInformation --> ActualShipping : <<choice>> 1 DespatchInformation --> EstimatedDelivery : <<choice>> 1 ActualShipping --> TimeOrDateTimePeriod : +estimatedDeliveryPeriod 0..1 </pre> <p>The diagram illustrates the structure of the DespatchInformation class. It contains four attributes: despatchDateTime, loadingDateTime, pickUpDateTime, and releaseDateTimeOfSupplier, all of type DateTime and with a cardinality of 0..1. DespatchInformation is associated with ActualShipping and EstimatedDelivery via <<choice>> relationships, both with a cardinality of 1. ActualShipping has two attributes: actualShipDateTime (DateTime) and estimatedDeliveryDateTime (DateTime, 0..1). ActualShipping is associated with TimeOrDateTimePeriod (from Date and Time) via a relationship labeled +estimatedDeliveryPeriod with a cardinality of 0..1.</p>		
Moved following structure into Common Library From Pay VAT TAX Information Extension VAT Invoice Party Extension Structure was not changed only included into Common Library for BMS Release 2.4.0	0.5.1	■

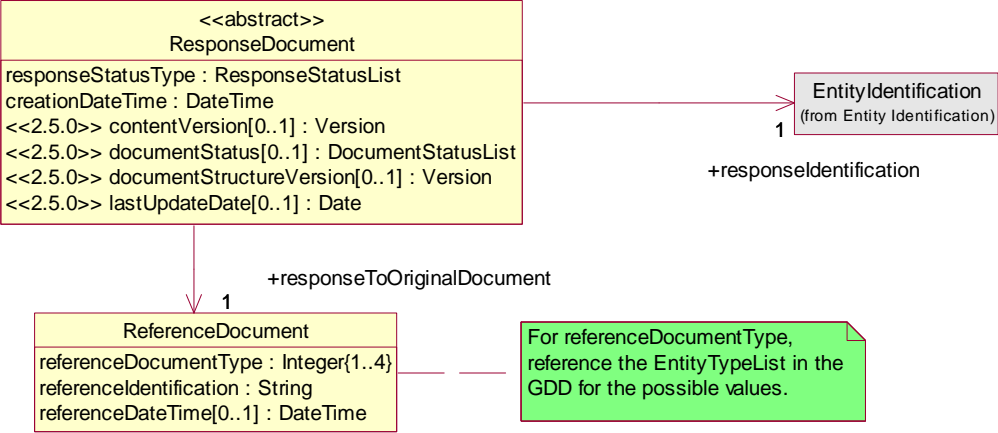
Change	BMS Doc Version	Associated CR Number
Package Dimension Removed the association from PackageDimension to Dimension As the reuse was redundant.	0.5.2	■
Common Library contains elements and code lists used in BMS Release 2.5.0 BMS 2.5.0 Change ResponseDocument <ul style="list-style-type: none"> Removed inheritance from Response Document to Document <ul style="list-style-type: none"> Added following attributes requirements sourced from Document Class to be backward compatible to Release 2.1.0 and pull requirements from 2.3.0 creationDateTime:DateTime contentVersion[0..1]:Version documentStatus[0..1]:DocumentStatusList documentStructureVersion[0..1]:Version lastUpdateDate[0..1]:Date Version 2.5 Release 	0.6.0	■

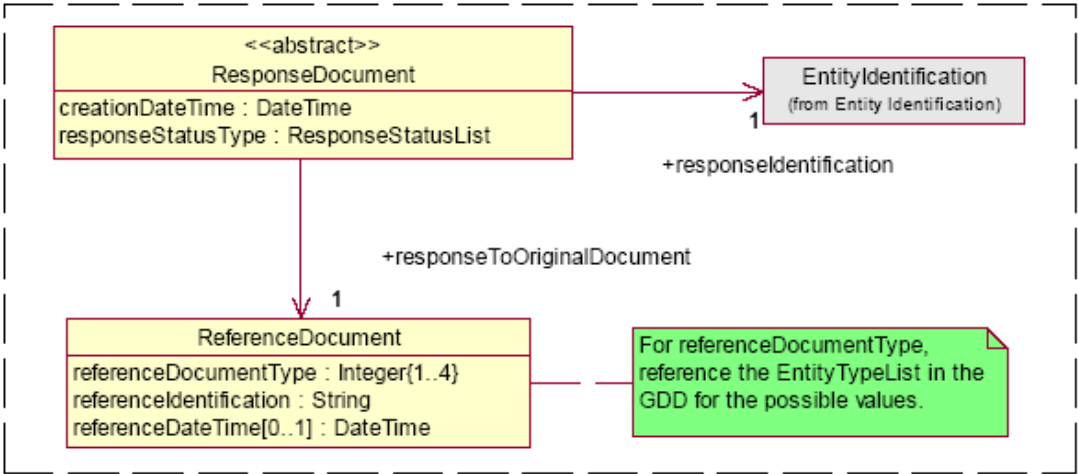
Change	BMS Doc Version	Associated CR Number
<p>Version 2.1 Release Snapshot History</p>  <pre> classDiagram class ResponseDocument { <<abstract>> creationDateTime : DateTime responseStatusType : ResponseStatusList } class EntityIdentification { (from Entity Identification) } class ReferenceDocument { referenceDocumentType : Integer{1..4} referenceIdentification : String referenceDateTime[0..1] : DateTime } ResponseDocument "1" -- "1" EntityIdentification : +responseIdentification ResponseDocument "1" -- "1" ReferenceDocument : +responseToOriginalDocument </pre> <p>Version 2.3 Release Snapshot History Response Document (CR 7-26/27/31)</p> <ul style="list-style-type: none"> • Added inheritance from ResponseDocument to Document • Deleted creationDateTime: DateTime 		

Change	BMS Doc Version	Associated CR Number
<div data-bbox="323 250 1182 764"> <pre> classDiagram class Document { <<abstract>> } class ResponseDocument { <<abstract>> responseStatusType : ResponseStatusList } class ReferenceDocument { referenceDocumentType : Integer{1..4} referenceIdentification : String referenceDateTime[0..1] : DateTime } class EntityIdentification { (from Entity Identification) } Document < -- ResponseDocument ResponseDocument "1" --> "1" EntityIdentification : +responseIdentification ResponseDocument "1" --> "1" ReferenceDocument : +responseToOriginalDocument </pre> <div data-bbox="829 651 1129 732" style="border: 1px solid green; background-color: #e0ffe0; padding: 2px;"> For referenceDocumentType, reference the EntityTypelist in the GDD for the possible values. </div> </div> <p data-bbox="323 878 659 979"> ISO639_Code Changed field length languageISOCode : String{1..5} </p> <div data-bbox="436 1008 1419 1089"> <p> ✔ Note: languageISOCode is a string length 1..5 for GDSN. eCom upgraded for BMS release 2.5.0 for consistency and usability in certain applications in China. </p> </div> <div data-bbox="344 1159 714 1279" style="border: 1px solid red; background-color: #ffffcc; padding: 5px; margin-top: 20px;"> <p> <<dataType>> ISO639_Code languageISOCode : String{1..5} </p> </div>		

Change	BMS Doc Version	Associated CR Number
<p>Simple Order Line Item (CR 8-5) Added taxRate[0..1]:Float BMS Release 2.5.0</p> <div data-bbox="325 427 1293 943" style="border: 1px solid black; padding: 10px;"> <pre> classDiagram class SimpleOrderLineItem { requestedQuantity : Quantity additionalOrderLineInstruction[0..1] : LongDescription lineItemActionCode[0..1] : OrderLineItemActionCodeList taxRate[0..1] : Float } class TradeItemIdentification { <<abstract>> } class MultiAmount { <<abstract>> } class ShipmentTransportationInformation { <<abstract>> } SimpleOrderLineItem -- > TradeItemIdentification SimpleOrderLineItem -- > MultiAmount SimpleOrderLineItem -- > ShipmentTransportationInformation TradeItemIdentification "1" --> SimpleOrderLineItem MultiAmount "0..1" --> SimpleOrderLineItem : +netPrice MultiAmount "0..1" --> SimpleOrderLineItem : +netAmount ShipmentTransportationInformation "0..1" --> SimpleOrderLineItem </pre> <p>UN/ECE Recommendation 20 is referenced as possible values for unit of measure.</p> <p>TradeItemIdentification (from Trade Item Identification) 1</p> <p>additionalOrderLineInstruction should only be used in exception circumstances if the information cannot be codified.</p> <p>ShipmentTransportationInformation (from Shipment Transportation Information) 0..1</p> </div> <p>BMS Release 2.4.0</p>		

Change	BMS Doc Version	Associated CR Number
<div data-bbox="323 250 1232 732"> <p>UNVECE Recommendation 20 is referenced as possible values for unit of measure.</p> <p>additionalOrderLineInstruction should only be used in exception circumstances if the information cannot be codified.</p> </div> <p>OrderHeaderIndicator</p> <p>Changed multiplicity from (1..1) to (0..1)</p> <ul style="list-style-type: none"> isApplicationReceiptAcknowledgementRequired[0..1] : Boolean isOrderFreeOfExciseTaxDuty[0..1] : Boolean <p>Added</p> <ul style="list-style-type: none"> orderInstruction[0..1] : SpecialOrderConditionCodeList <p>BMS Release 2.5.0</p> <div data-bbox="323 1068 1178 1239"> <p>OrderHeaderIndicator</p> <p>isApplicationReceiptAcknowledgementRequired[0..1] : Boolean</p> <p>isOrderFreeOfExciseTaxDuty[0..1] : Boolean</p> <p><<2.5.0>> orderInstruction[0..1] : SpecialOrderConditionCodeList</p> </div> <p>BMS Release 2.4.0</p> <div data-bbox="323 1325 1079 1458"> <p>OrderHeaderIndicator</p> <p>isApplicationReceiptAcknowledgementRequired : Boolean</p> <p>isOrderFreeOfExciseTaxDuty : Boolean</p> </div>		

Change	BMS Doc Version	Associated CR Number
<p>Added SpecialConditionCodeList NO_PARTIAL_DELIVERY_ALLOWED PARTIAL_DELIVERY_ALLOWED</p> <p>Order Party Information (CR 8-55) BMS Order Party Information 2.5.0 Order Party Information Added Attributes</p> <ul style="list-style-type: none"> • buyerCompanyRegistrationNumber[0..1] : String{1..70} • sellerCompanyRegistrationNumber[0..1] : String{1..70} <p>Order Party Information BMS 2.5.0</p> <div data-bbox="323 745 1173 1209" style="border: 1px solid black; padding: 10px;"> <pre> classDiagram class OrderPartyInformation { <<2.5.0>> buyerCompanyRegistrationNumber[0..1] : String{1..70} <<2.5.0>> sellerCompanyRegistrationNumber[0..1] : String{1..70} } class PartyIdentification { <<from Party Identification>> } class Contact { <<from Contact>> } OrderPartyInformation "1" -- "1" PartyIdentification : +seller OrderPartyInformation "0..1" -- "0..1" PartyIdentification : +billTo OrderPartyInformation "1" -- "1" PartyIdentification : +buyer OrderPartyInformation "0..1" -- "0..1" Contact : +orderContact OrderPartyInformation "0..1" -- "0..1" Contact : +goodsRequirementsPlanner </pre> </div> <p>Order Party Information BMS Release 2.4.0</p>		

Change	BMS Doc Version	Associated CR Number
<div data-bbox="323 250 825 597"> <pre> classDiagram class OrderPartyInformation class PartyIdentification["PartyIdentification (from Party Identification)"] class Contact["Contact (from Contact)"] OrderPartyInformation "1" -- "1" PartyIdentification : +seller OrderPartyInformation "0..1" -- "0..1" PartyIdentification : +billTo OrderPartyInformation "1" -- "1" PartyIdentification : +buyer OrderPartyInformation "0..1" -- "0..1" Contact : +orderContact OrderPartyInformation "0..1" -- "0..1" Contact : +goodsRequirementsPlanner </pre> </div> <p data-bbox="323 678 1360 732">Added Shipment Detail in Common Library as it is being used by Multi Shipment Order and Order Response (CR 8-53). No structure changes to Shipment Detail.</p> <div data-bbox="323 776 533 800"> <p>BMS Version 2.5.0</p> </div> <div data-bbox="323 812 1325 1227"> <pre> classDiagram class ShipmentDetail["ShipmentDetail (requestedQuantity : Quantity)"] class PartyIdentification["PartyIdentification (from Party Identification)"] class DocumentOrDocumentLineReference["DocumentOrDocumentLineReference (from Document Reference)"] class OrderLogisticalDateGroup["OrderLogisticalDateGroup (from Order Logistical Information)"] class ShipmentTransportationInformation["ShipmentTransportationInformation (from Shipment Transportation Information)"] class PartyIdentification2["PartyIdentification (from Party Identification)"] class InventoryLocation["InventoryLocation"] ShipmentDetail "0..1" -- "0..1" PartyIdentification : +ultimateConsignee ShipmentDetail "0..1" -- "0..1" PartyIdentification : +shipFrom ShipmentDetail "0..1" -- "0..1" PartyIdentification : +shipTo ShipmentDetail "0..1" -- "0..1" DocumentOrDocumentLineReference : +purchaseConditions ShipmentDetail "0..1" -- "0..1" OrderLogisticalDateGroup ShipmentDetail "0..1" -- "0..1" ShipmentTransportationInformation PartyIdentification "0..1" -- "0..1" PartyIdentification2 : +inventoryLocation </pre> </div> <p data-bbox="323 1308 632 1406">BMS Invoice Tax Information 8-209 BMS Release 2.5.0</p>		

Change	BMS Doc Version	Associated CR Number
<p>Class Invoice Tax Information</p> <p>Added dutyTaxFeeDescription[0..1]:String{1..35}</p> <div data-bbox="323 386 947 688" style="border: 1px solid black; padding: 5px; margin: 10px 0;"> <p style="text-align: center;">InvoiceTaxInformation</p> <pre><<2.5.0>> dutyTaxFeeDescription[0..1] : String{1..35} dutyTaxFeeType[0..1] : DutyTaxFeeTypeCodeList extension[0..1] : Extension taxableAmount[0..1] : Float taxableAmountInTaxAccountingCurrency[0..1] : Float taxAmount[0..1] : Float taxAmountInTaxAccountingCurrency[0..1] : Float taxPercentage[0..1] : Percentage{3.2}</pre> </div> <p>BMS Release 2.4.0</p> <div data-bbox="323 802 1024 1107" style="border: 1px solid black; padding: 5px; margin: 10px 0;"> <p style="text-align: center;">InvoiceTaxInformation</p> <pre>dutyTaxFeeType[0..1] : DutyTaxFeeTypeCodeList extension[0..1] : Extension taxableAmount[0..1] : Float taxableAmountInTaxAccountingCurrency[0..1] : Float taxAmount[0..1] : Float taxAmountInTaxAccountingCurrency[0..1] : Float taxPercentage[0..1] : Percentage{3.2}</pre> </div> <p>DutyTaxFeeTypeCodeList Added code value NON_VALUE_ADDED_TAX</p> <p>Removed from Common Library and added to Invoice Release 2.5.0 VAT Invoice Party Extension VAT Tax Information Extension</p>		

Change	BMS Doc Version	Associated CR Number
<p>Reusing Trade Item Tax Information structure from GDSN community. No UML or GDD changes were made to Trade Item tax Information</p> <div data-bbox="323 386 1220 938" style="border: 1px solid black; padding: 10px; margin: 10px 0;"> <pre> classDiagram class TradeItemTaxInformation { <<choice>> } class AbstractAmount { <<abstract>> (from Abstract Amount) } class TradeItemTaxAmount { taxAmount[0..1] : Decimal(13.4) } class TradeItemTaxRate { taxRate[0..1] : Percentage(3.2) } class TaxAgency { taxAgencyCode : String(1..3) taxTypeCode : String(1..14) taxApplicabilityCode[0..1] : String(1..35) taxTypeDescription[0..1] : String(1..35) } TradeItemTaxInformation "1..*" --> "1..*" TradeItemTaxAmount TradeItemTaxInformation "1..*" --> "1..*" TradeItemTaxRate AbstractAmount < -- TradeItemTaxAmount TradeItemTaxAmount "1" --> "1" TaxAgency TradeItemTaxRate "1" --> "1" TaxAgency </pre> </div> <p>Updated UML Class Diagram to match XSD field length BMS Release 2.5.0</p>		

Change	BMS Doc Version	Associated CR Number
<div style="border: 1px solid black; padding: 5px;"> <pre> classDiagram class Contact class MultiDescription["MultiDescription (from Description)"] class CommunicationChannel Contact "1" --> MultiDescription : +personOrDepartmentName Contact "0..*" --> CommunicationChannel class CommunicationChannel { communicationChannelCode : CommunicationChannelCodeList communicationNumber : String{1..70} } </pre> </div> <p>BMS Release</p> <div style="border: 1px solid black; padding: 5px;"> <pre> classDiagram class Contact class MultiDescription["MultiDescription (from Description)"] class CommunicationChannel Contact "1" --> MultiDescription : +personOrDepartmentName Contact "0..*" --> CommunicationChannel class CommunicationChannel { communicationChannelCode : CommunicationChannelCodeList communicationNumber : String } </pre> </div>		
For BMS Release 2.5.0 <ul style="list-style-type: none"> eBallot Approved, Updated BMS to 'Approved' Status Update version to 'Issue' 	Issue 0.6.0	Not Applicable
<p>For BMS Release 2.6.0</p> <ul style="list-style-type: none"> Moved Code Lists DocumentCommandTypeList and ApplicationReceiptAcknowledgementStatusList from Application Receipt Acknowledgement BSD to Common Library BSD. <p><i>Note: For DocumentCommandType List, the GDD report has an additional value of 'DELETED' since last published version of the Application Acknowledgement Receipt.</i></p>	Draft 0.7.0	CR 09-134 (MR); CR 08-103; CR 08-107; CR 08-127

Change	BMS Doc Version	Associated CR Number
<p>08-103:</p> <ul style="list-style-type: none"> • Additions to Code List: ErrorOrWarningList <ol style="list-style-type: none"> 1. Article out of assortment Description: Article normally part of a standard assortment is unavailable. 2. Blocked article Description: Article has been blocked by supplier, e.g. for the reason of quality problems. 3. Not permitted by Law Description: Article may not be delivered to certain buyers because this is not permitted by law, e.g. the buyer is not licensed for buying opiates. 4. Maximum Ordered Quantity exceeded Description: Number of ordered articles exceeds the maximum amount, set by supplier for a certain buyer. <p>08-107</p> <ul style="list-style-type: none"> • Added optional attribute 'backOrderQuantityIndicator' to ShipmentDetail to support indicating a Back Order Quantity in the Order Response message • Added Code List: NonBinaryLogicCodeList, which is the data type for backOrderQuantityIndicator. <div data-bbox="359 894 1050 1008" style="border: 1px solid black; padding: 5px; margin: 10px 0;"> <p style="text-align: center; background-color: #ffffcc;">ShipmentDetail</p> <p>requestedQuantity : Quantity backOrderQuantityIndicator[0..1] : NonBinaryLogicCodeList</p> </div> <p>08-127</p> <ul style="list-style-type: none"> • Added optional attribute 'invoiceAllowanceChargePercentage' to InvoiceAllowanceCharge. <div data-bbox="420 1157 926 1448" style="border: 1px solid black; padding: 10px; margin: 10px 0;"> <div style="border: 1px solid black; background-color: #ffffcc; padding: 5px; margin-bottom: 10px;"> <p style="text-align: center;">InvoiceAllowanceCharge</p> <p>invoiceAllowanceChargeAmount[0..1] : Float invoiceAllowanceChargeType[0..1] : AllowanceChargeList invoiceAllowanceOrChargeType[0..1] : AllowanceOrChargeList invoiceAllowanceChargePercentage[0..1] : Percentage</p> </div> <div style="text-align: center;"> <p>↓ 0..1</p> </div> <div style="border: 1px solid black; background-color: #e0e0e0; padding: 5px; margin: 0 auto; width: fit-content;"> <p style="text-align: center;">InvoiceTaxInformation (from Invoice Tax Information)</p> </div> </div>		

Change	BMS Doc Version	Associated CR Number
Updates based on TSD Review: <ul style="list-style-type: none"> Updated Table of Contents 08-107 – Corrected attribute name - backOrderQuantityIndicator & corrected typo in comments for NonBinaryLogicCodeList 	Draft 0.7.1	Not Applicable
eCom BMS 2.6.0 – CR 08-107 Based on BRG Review, remove backOrderQuantityIndicator. This attribute will be replaced in the Order Response message with an association to Shipment Detail. <div data-bbox="342 483 684 565" style="border: 1px solid black; padding: 2px; margin: 5px 0;"> ShipmentDetail requestedQuantity : Quantity </div>	Draft 0.7.2	CR 08-107
eCom BMS 2.6.0 – Updates per TSD Review StopGap Report Update to fix Legacy issue in Code List name. Change name from 'DocumentCommandTypeList' to 'DocumentCommandList' per usage in XML schemas to ensure backward compatibility	Draft 0.7.3	CR 09-134